

GETTYSBURG

JULY 3 1863

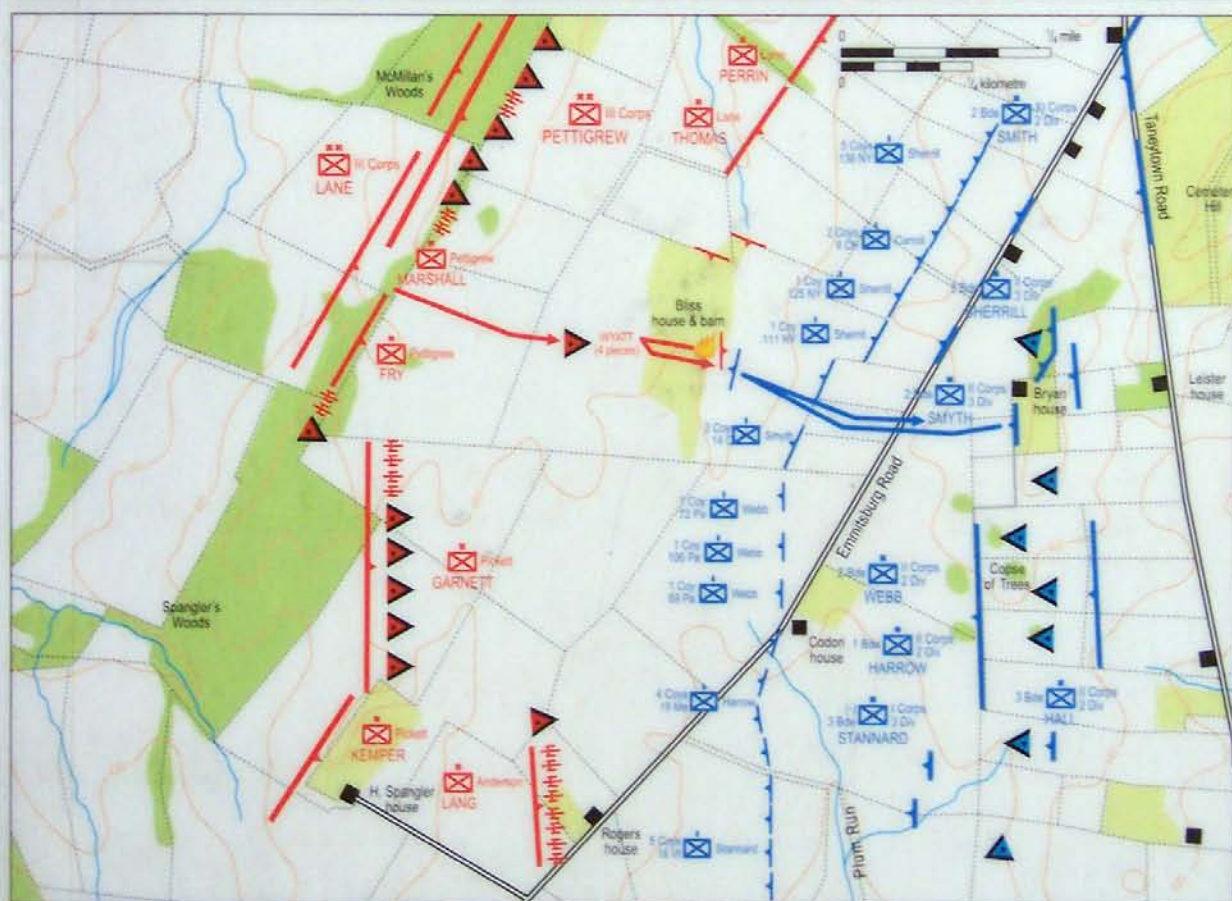

**UNION: THE ARMY
OF THE POTOMAC**

James Arnold & Roberta Wiener

INCLUDES LARGE
FOLD-OUT MAP OF
BATTLEFIELD

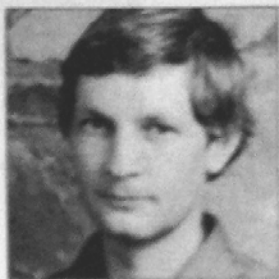

**JAMES ARNOLD
AND ROBERTA WIENER**
are US-born freelance
writers who have contributed
to numerous military
publications. James spent
his formative years in
Europe and used the
opportunity to study the
sites of historic battlefields.
He has 15 published books
to his credit, many of them
focusing on the Napoleonic
campaigns and the American
Civil War. Roberta Wiener has
co-authored several works
of history and edited history
and science books, including
a children's encyclopaedia.
She also carries out archival
research on military
history topics.

SERIES EDITOR: JOHN MOORE

ORDER OF BATTLE 11

GETTYSBURG

JULY 3 1863

UNION: THE ARMY OF THE POTOMAC

JAMES ARNOLD and ROBERTA WIENER

First published in Great Britain in 2000 by Osprey Publishing, Elms Court, Chapel Way, Botley, Oxford OX2 9LP United Kingdom
Email: info@ospreypublishing.com

© 2000 Ravelin Limited
Exclusive publishing rights Osprey Publishing Limited

All rights reserved. Apart from any fair dealing for the purpose of private study, research, criticism or review, as permitted under the Copyright, Designs and Patents Act, 1988, no part of this publication may be reproduced, stored in a retrieval system, or transmitted in any form or by any means, electronic, electrical, chemical, mechanical, optical, photocopying, recording or otherwise, without the prior written permission of the copyright owner. Enquiries should be addressed to the Publishers.

ISBN 1 85532 861 5

Osprey Series Editor: Lee Johnson
Ravelin Series Editor: John Moore
Research Co-ordinator: Diane Moore
Design: Ravelin Limited, Braceborough, Lincolnshire, United Kingdom
Cartography: Chapman Bounford and Associates, London, United Kingdom
Origination by Valhaven Ltd, Isleworth, United Kingdom
Printed in China through World Print Ltd

00 01 02 10 9 8 7 6 5 4 3 2 1

FOR A CATALOGUE OF ALL BOOKS PUBLISHED BY OSPREY MILITARY AND AVIATION PLEASE WRITE TO:

The Marketing Manager, Osprey Direct, P.O. Box 140, Wellingborough, Northants, NN8 4ZA, United Kingdom. Email: info@ospreydirect.co.uk
The Marketing Manager, Osprey Direct USA, PO Box 130, Sterling Heights, MI 48311-0130, USA. Email: info@ospreydirectusa.com

VISIT OSPREY AT www.ospreypublishing.com

Series style

The style of presentation adopted in the Order of Battle series is designed to provide quickly the maximum information for the reader.

Order of Battle Unit Diagrams – all 'active' units in the ORBAT, that is those present and engaged on the battlefield, are drawn in black. Those units not yet arrived or those present on the battlefield but unengaged are 'shadowed'.

Unit Data Panels – similarly, those units which are present and engaged are provided with company details for infantry and cavalry bodies and with details of the pieces for artillery.

Battlefield Maps – units engaged are shown in the respective colours of their armies. Units shown as 'shadowed' are those deployed for battle but not engaged at the time. Dotted arrows depict actual or planned movements before or after the main action covered by the map.

Order of Battle timelines

Battle page timelines – each volume concerns the Order of Battle for the armies involved. Rarely are the forces available to a commander committed into action as per his ORBAT. To help the reader follow the sequence of events, a timeline is provided at the bottom of each 'battle' page. This timeline gives the following information:

The top line bar defines the actual time of the actions being described in that battle section.

The middle line shows the time period covered by the whole day's action.

The bottom line indicates the page numbers of the other, often interlinked, actions covered in this book.

[Greyed out header]				
0800 hrs	0900	1000	1100	1200
pp45-47	48-49 & 52-55	50-51		

Key to Military Series symbols

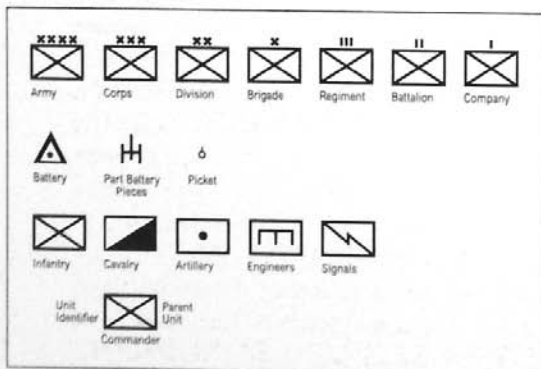

Editor's note

Wherever possible primary sources have been used in compiling the information in this volume. Total casualties noted against regiments indicate approximate numbers killed, wounded and missing/captured during all three days at Gettysburg.

Order of Battle and detailed strength data was used with permission from *Regimental Strengths and Losses at Gettysburg* (Hightstown, N.J.: Longstreet House, 1994) by John W Busey and David G. Martin.

CONTENTS

THE ARMY OF THE POTOMAC — PLANNING	4
I CORPS	8
1st Division	10
2nd Division	12
3rd Division	13
I Corps Artillery Brigade	16
I CORPS' BATTLES – Stannard's Brigade – The Vermont Brigade opposes Pickett	17
II CORPS	20
1st Division	22
2nd Division	24
3rd Division	29
II Corps Artillery Brigade	34
II CORPS' BATTLES – Gibbon's and Hays' Divisions – Holding Cemetery Ridge	35
III CORPS	42
1st Division	44
2nd Division	45
III Corps Artillery Brigade	47
V CORPS	48
1st Division	50
2nd Division	51
3rd Division	52
V Corps Artillery Brigade	54
VI CORPS	55
1st Division	57
2nd Division	58
3rd Division	59
VI Corps Artillery Brigade	60
XI CORPS	61
1st Division	62
2nd Division	63
3rd Division	64
XI Corps Artillery Brigade	65
XII CORPS	66
1st Division	67
2nd Division	71
XII Corps Artillery Brigade	74
XII CORPS' BATTLES – Geary's and Ruger's Divisions – Johnson Repulsed	75
THE ARTILLERY RESERVE	77
THE CAVALRY CORPS	79
1st Division	81
2nd Division	83
3rd Division	86
CAVALRY CORPS' BATTLES –	
Farnsworth's Brigade - 'Kill Cavalry' Attacks the Confederate Right	90
Custer's and McIntosh's Brigades – Action at Rummel's Farm	91
WARGAMING GETTYSBURG & SELECT BIBLIOGRAPHY	96

THE ARMY OF THE POTOMAC

Gettysburg – July 3, 1863

Planning

At the close of fighting on July 2, Major-General George Meade sent a dispatch to General-in-Chief Henry Halleck: 'The enemy attacked me about 4 p.m. this day, and, after one of the severest contests of the war, was repulsed at all points. We have suffered considerably in killed and wounded ... I shall remain in my present position tomorrow, but am not prepared to say, until better advised of the condition of the army, whether my operations will be of an offensive or defensive character.' To ascertain his army's condition, Meade summoned his corps commanders to a council of war.

Napoleon always had scorned such councils, saying they typically led to inaction and always produced a cautious consensus. But Meade had held army command since only June 28. At no time had he been able to meet with all of his senior officers. Although he had personally already resolved to remain on the field, he wanted to learn the attitudes of his corps commanders. To this end, he posed three questions: 1. 'Under existing circumstances is it advisable for this army to remain in its present position, or to retire to another nearer its base of supplies? 2. It being determined to remain in present position, shall the army attack or wait the attack of the enemy? 3. If we wait attack, how long?'

None of his senior officers wanted to retreat. General Gibbon recommended correcting the army's position, saying the army was in no shape to attack, and advised against any movement unless Lee moved first. General Williams – present because XII Corps commander, General Slocum, still conceived of



After the Battle of Gettysburg, Major-General George Meade (*centre, with two of his staff*) received criticism from Lincoln, and many others, for failing to defeat decisively Lee's battered army. (USAMHI, Carlisle)

ARMY HEADQUARTERS 50 Staff and Field Officers

ORDERLIES/ESCORT

1 Co. Oneida New York Cavalry

Captain Daniel P. Mann

42 troops present for duty equipped

himself as a wing commander and thus Williams as commander of XII Corps – replied simply, 'Stay. Wait. Attack. One day.' Both Generals Birney and Sykes concurred with Williams. Newton agreed with Gibbon that the army's position be corrected, to avoid attack for sure, but worried that, if the army remained passive, then Lee would operate against its line of communications. Howard recommended waiting until 1600 hrs for an attack and then, if Lee had not struck,

THE ARMY OF THE POTOMAC – GETTYSBURG – July 3

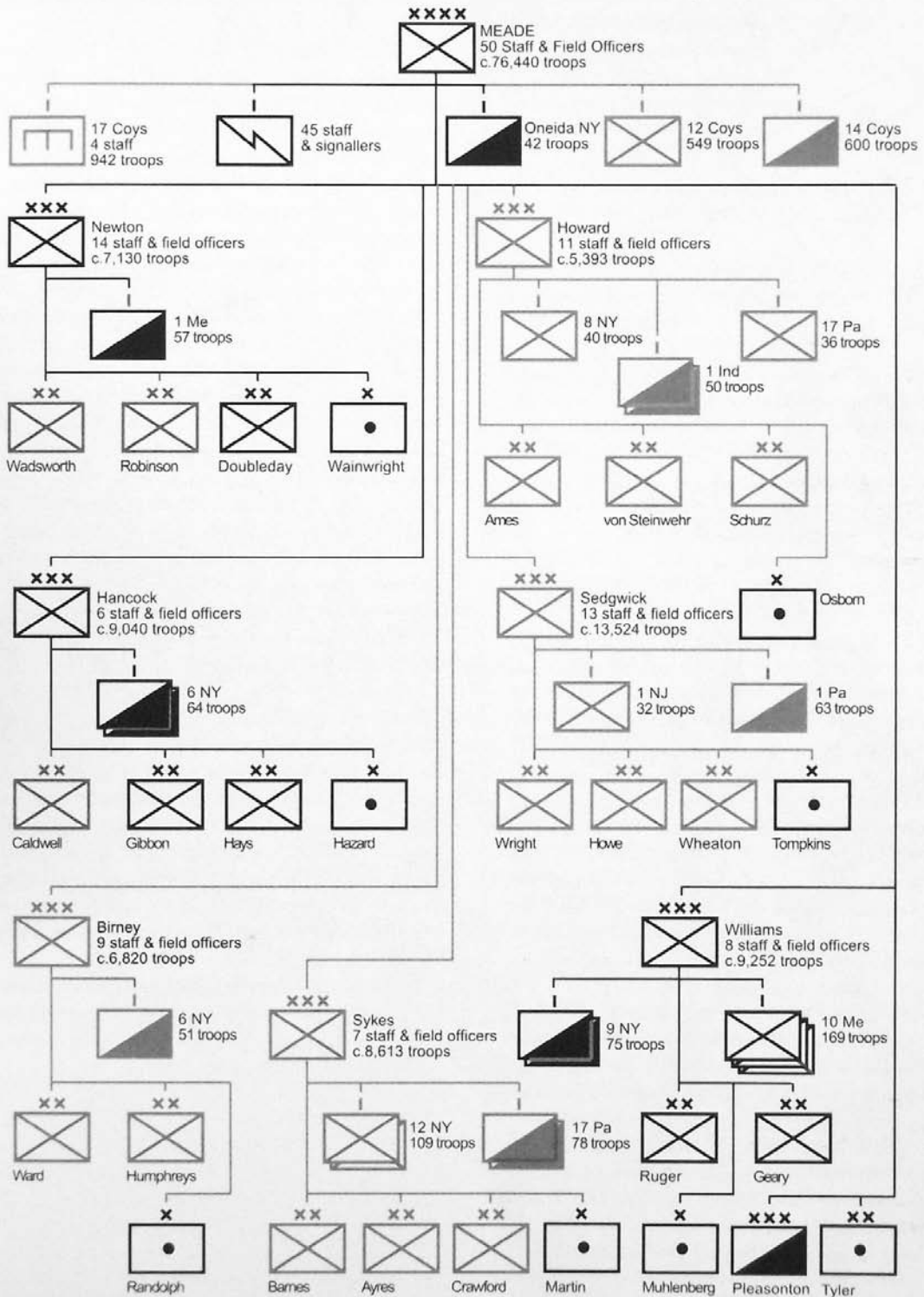

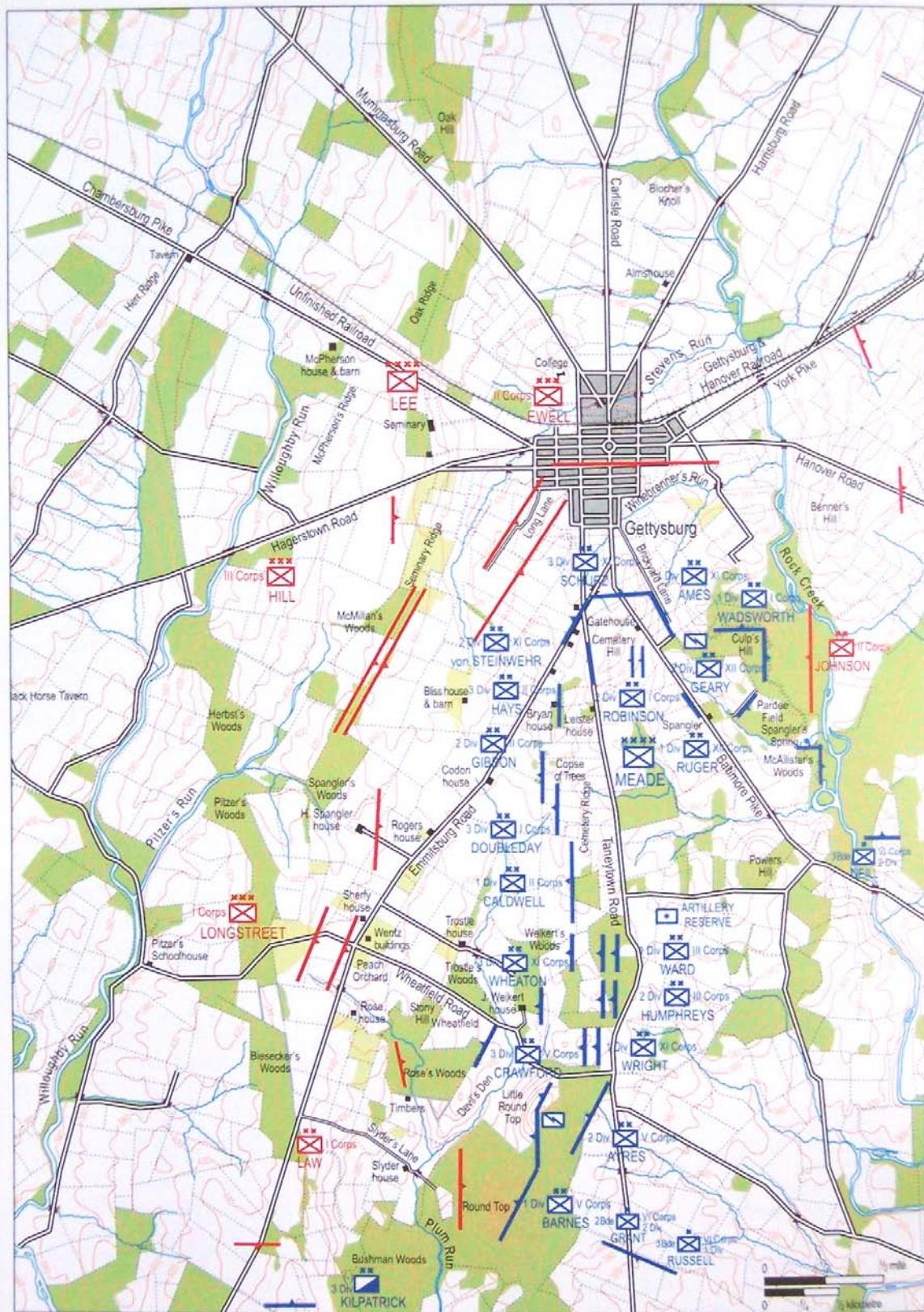

For July 3, General Meade maintained his positions on Little Round Top and Cemetery Hill and reinforced Culp's Hill and Cemetery Ridge with ample reserves.

to attack the Confederates. Hancock wanted to improve the army's position and not attack unless Lee cut the army's line of communications. He ambiguously added that the army could not wait too long. It could not be idle. Sedgwick wanted to wait attack at least one day. Slocum bluntly said, 'Stay and fight it out.'

Clearly the collective wisdom of the army's senior command much preferred remaining on the defensive. However, they had enough experience with Lee's flanking manoeuvres to fear for their line of communications. Many also feared what Lee could do since they were ceding him the initiative. Each commander also provided his best estimate of their remaining number of effective soldiers. The total was 58,000. As the meeting was winding down, Slocum learned that the rebels had captured the abandoned Union works on lower Culp's Hill. His response was to order the enemy driven out at dawn.

During final discussions, the sardonic engineer officer, Newton, commented that the army's position was better now than it had been on either of the first two days, because the Confederates 'have hammered us into a solid position they cannot whip us out of'. Having resolved to hold its ground, the council ended about midnight.

At an informal lunch the next day Meade commented that he anticipated another attack against his left some time that afternoon but that Hancock expected an assault against the centre. When the rebel artillery bombardment began, the overshoots hit heavily around Meade's headquarters. Sixteen headquarters' horses tied to the rail in front of the Leister House were killed. Although he was reluctant to move because he feared that any couriers would

General Meade initially made his headquarters at the Leister farmhouse on the Taneytown Road, south of Gettysburg. (U.S. National Archives)



ARMY HEADQUARTERS COMMAND

PROVOST MARSHAL GENERAL

Brigadier-General Marsena R. Patrick

8 Staff and Field Officers

93rd Regiment New York State Volunteers

(Northern Sharpshooters)

(not present at Gettysburg)

Colonel John S. Crocker

4 Cos. – 148 troops present for duty equipped

8th United States Infantry Regiment

(not present at Gettysburg)

Captain Edwin W. H. Read

Cos. A through G and I – 401 troops present for duty equipped

2nd Pennsylvania Cavalry Regiment

Colonel Richard Butler Price

Cos. A through M – 489 troops present for duty equipped

6th Pennsylvania Cavalry Regiment

Captain James Starr

Cos. E and I – 81 troops present for duty equipped

United States Regular Cavalry

15 troops present for duty equipped

Detachments from 1st, 2nd, 5th and 6th Cavalry Regiments.

ENGINEERS

(none present at Gettysburg)

Brigadier-General Henry W. Benham

4 Staff and Field Officers

15th New York State Volunteer Engineer Regiment

Major Walter L. Cassin

Cos. A, B and C – 126 troops present for duty equipped

50th New York State Volunteer Engineer Regiment

Colonel William H. Pettes

Cos. A through K – 479 troops present for duty equipped

United States Engineer Battalion

Captain George H. Mendell

Cos. A through D – 337 troops present for duty equipped

SIGNAL CORPS

Captain Lemuel B. Norton

45 Staff and Signallers

have trouble finding him, Meade retired across the road into a barn. Still under heavy fire, he then shifted his headquarters to a signal station on Stevens' Knoll between Cemetery Hill and Culp's Hill. While en route he stopped first at Cemetery Hill. He galloped over to Major Thomas Osborn, the commander of XI Corps Artillery Brigade, and with considerable excitement asked, 'Could he hold?' Osborn replied, 'Yes.' Meade said that the battle's outcome depended upon holding this hill. He repeated, 'Can you stay here? Are your men thoroughly in hand?' Again, Osborn said yes. Reassured, Meade rode off to Stevens' Knoll. By the time he returned, the great charge had been defeated.

THE ARMY OF THE POTOMAC



I CORPS

Dawn on July 3 found I Corps' three divisions deployed as follows: 1st Division on Culp's Hill in the same position it had occupied while helping to repel the attacks on the previous evening; 2nd Division on Cemetery Hill ready to support XI or II Corps; 3rd Division on the left centre of Cemetery Ridge adjoining the left of II Corps.

The commander of I Corps, Major-General John Newton, played an important role when he participated in Meade's Council of War. He was a respected engineer and his fellow officers listened when he advocated remaining to fight another day. Early on July 3, Newton deployed all Federal troops between II Corps on Cemetery Ridge and V Corps on Little Round Top. Initially he found a half-mile-wide gap between the left of Doubleday's 3rd Division and the forces of Sykes' V Corps. He reported this omission to Meade, who authorised him to seek help from Sedgwick. While riding to the army's left, Newton observed Caldwell's II Corps division in reserve and convinced that officer to move his men to the left of Doubleday. This was exactly the sort of meddling that had caused such harm to the Union left the previous day. In this case, Newton's initiative did not cause any difficulties.

Sedgwick claimed that he could spare only his New Jersey Brigade commanded by Torbett. Newton

Meade had the greatest confidence in Major-General John Newton, elevating him to corps command over Doubleday. At lunch on July 3, before the rebel assault, Newton and Gibbon traded gibes over their fitness for their respective field promotions. (MARS)



directed Torbett into position on Caldwell's left. Since I Corps artillery was in position on Cemetery Hill, Newton obtained permission to call upon the Artillery Reserve.

By noon Newton had completed his dispositions. The left-centre of Cemetery Ridge was held by infantry from I, II, and VI Corps, as well as artillery from the Artillery Reserve, III Corps, and a VI Corps battery. This force assured Newton that his line was 'very secure'.

Following the battle, I Corps remained in position on July 4 to attend to collecting and caring for the wounded. The next day it collected some 2,958 discarded shoulder arms, the great majority of which were Enfield rifled muskets, and buried the fallen including 7 Confederate officers and 404 Confederate men. On July 6 the corps marched to Emmitsburg.

Summary statistics indicate how hard the corps had fought. During the battle its soldiers had fired some 227,000 rounds of small-arms ammunition. It captured

I CORPS

Major-General John Newton

14 Staff and Field Officers

First Division

Brigadier-General James Samuel Wadsworth

Second Division

Brigadier-General John Cleveland Robinson

Third Division

Major-General Abner Doubleday

I Corps' Artillery

Colonel Charles S. Wainwright

I CORPS HEADQUARTERS

ESCORT

Co. L, 1st Maine Cavalry Regiment

Captain Constantine Taylor

57 troops present for duty equipped

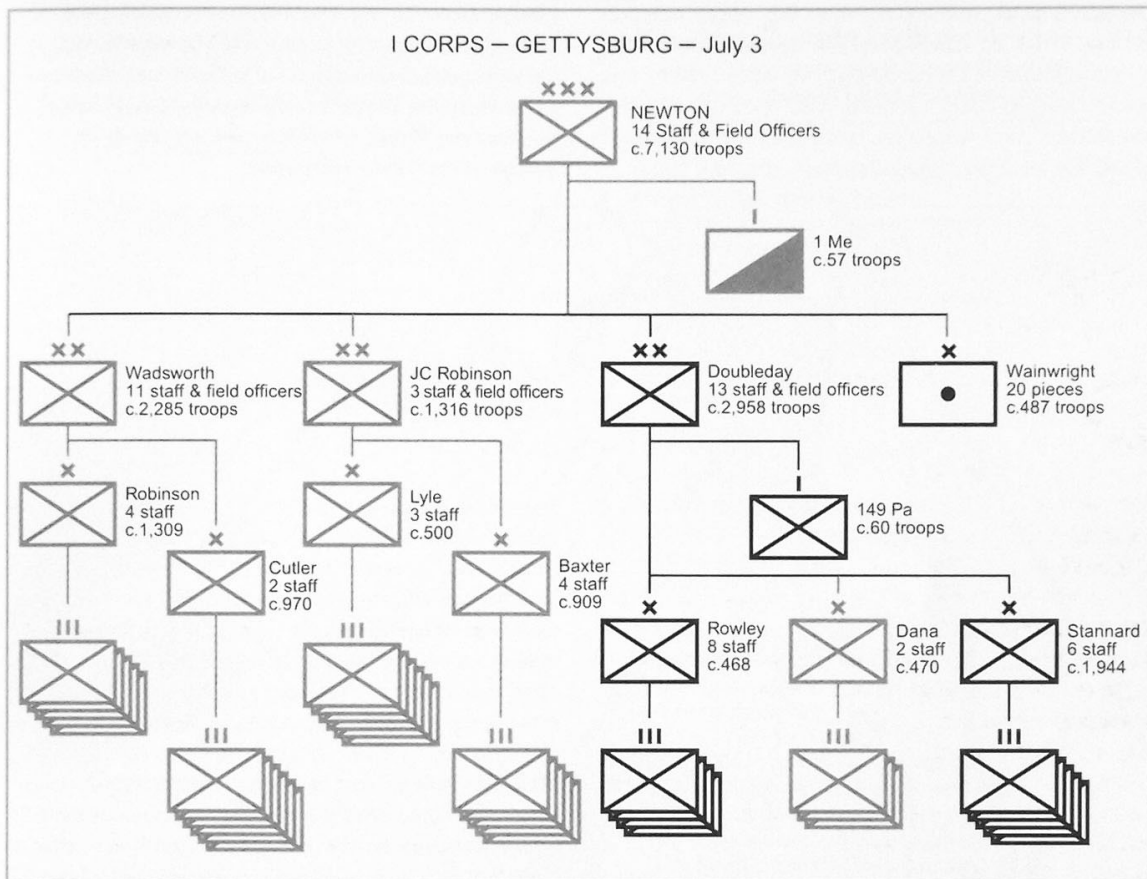

seven colours, losing one back again. The attached artillery had fought well, losing one gun, a 3-inch rifle belonging to Battery L, 1st New York. The corps as a

A Michigan regiment (probably the 24th Regiment Michigan Volunteer Infantry). The self-sacrifice of the Iron Brigade on July 1 gave the army the opportunity to stand its ground on July 2 and 3. (U.S. National Archives)



whole lost 42 officers and 624 men killed; 261 officers and 2,969 men wounded; 83 officers and 2,079 men missing or captured. This total of over 6,000 casualties was about half of the force with which the corps had entered battle and was about 50 percent higher than the total for any other Federal corps.

The losses were never made good. When Meade conceived an army-wide consolidation after the 1863 campaign year ended, one of the corps earmarked for elimination was I Corps. In March 1864 the corps was disbanded. A combat record that had begun when it was part of McDowell's old III Corps ended with the corps' sacrifice at Gettysburg.

As for Newton, he held every expectation of advancement following the battle. Meade demonstrated his confidence in the engineer officer when Hancock was wounded at the height of Pickett's Charge. Meade gave Newton control of the entire line between V Corps at Little Round Top and XI Corps on Cemetery Hill. Newton led I Corps during the autumn campaign of 1863. When the corps was disbanded he was without a command. Recalling his role in undermining Burnside, many officials in the War

Department, as well as some in the upper echelon of the Army of the Potomac, viewed Newton as a troublemaker. Accordingly, in April 1864, his commission to major general was revoked. Newton transferred west where he served for the remainder of the war as a brigadier-general.

I Corps deployed with two divisions occupying the strategically important positions on Culp's Hill and Cemetery Hill. Doubleday's 3rd Division was deployed to reinforce the left-centre of the main Federal battleline on Cemetery Ridge, where it would face the great charge of the Confederate army.

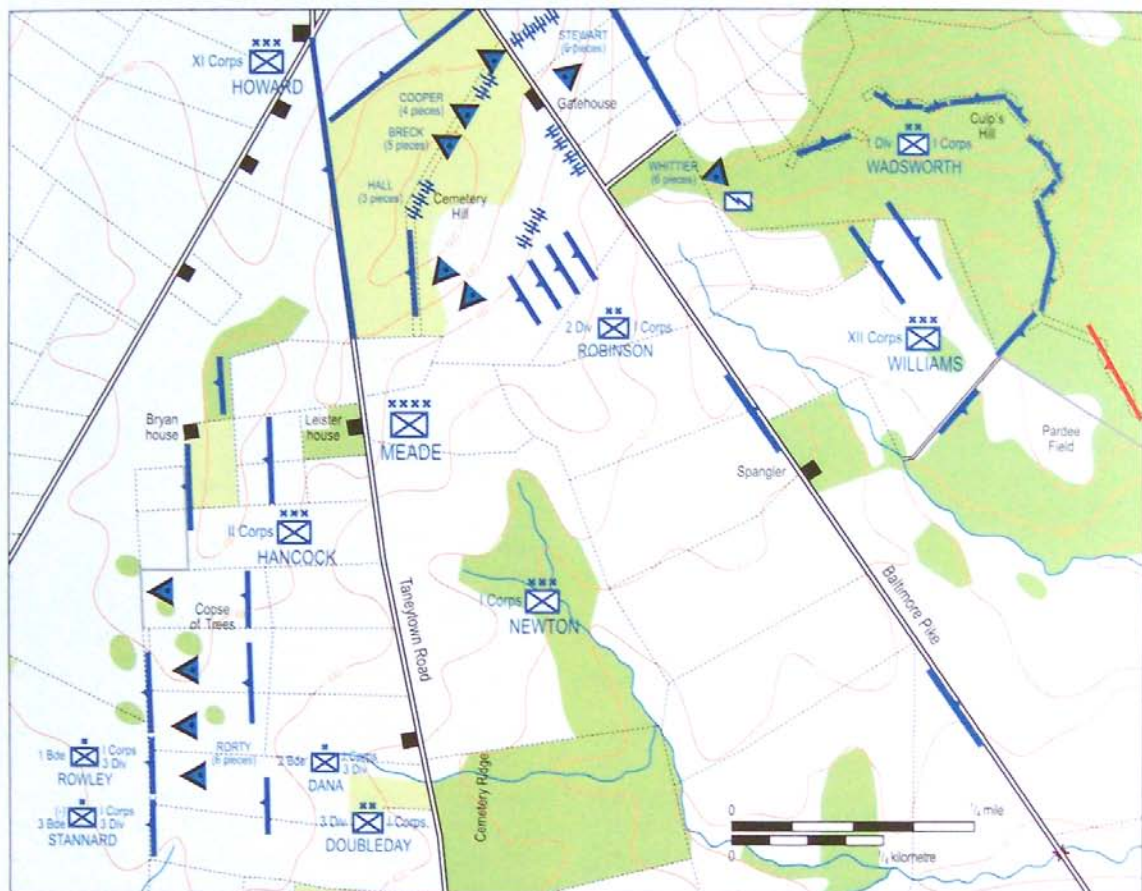

I Corps – 1st Division



After hard fighting on July 1 and 2, the balance of the 1st Division did not engage for the remainder of the battle. Wadsworth exercised little useful leadership on July 3. His main contribution occurred when he heard the heavy sounds of combat to his right and informed Meade that Geary was wasting ammunition!

Two regiments of the 2nd Brigade were unique in that they had experienced combat on July 1 and 2, and

would also take part in serious fighting on July 3. The 147th New York and the 14th Brooklyn, the latter clad in their distinctive chasseur-style uniform, had shared the brigade's battering on July 1. The next day they had helped Greene's Brigade repel attacks against Culp's Hill. The 147th was behind its works at 0330 hrs on July 3 and joined in the general fusillade that began at daybreak. By 1000 hrs, soldiers had been relieved in the front line four times so they could clean fouled

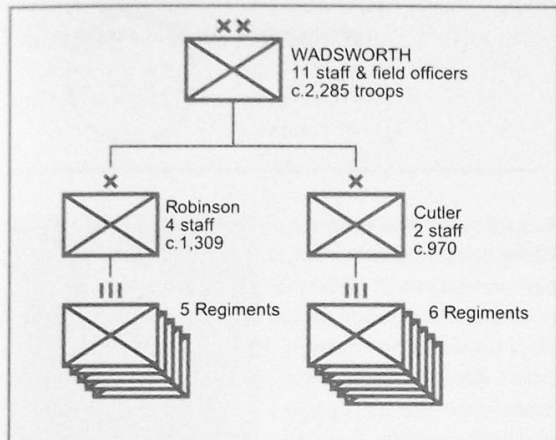

muskets after firing 200 rounds apiece. A lieutenant wrote in his diary that it was 'a noisy day on the whole' featuring 'beef & gunpowder for supper'. The young soldiers of the 14th Brooklyn saw less combat on July 3. An eyewitness saw them advance into the front line: 'When the word of command came the lips tightened, the eyes flashed, every nerve was strained, and they moved forward with almost mechanical ease and firmness.' The chasseurs manned a stout line of works that sheltered them from most enemy fire and fired off their ammunition against successive Confederate attacks. Their flag, which rose above the works, was riddled by musketry.

Wadsworth wrote of his officers' performance: 'The officers of my staff and of my command performed their whole duty without exception. Under these circumstances I cannot particularly commend any of them without doing injustice to others equally meritorious.' Curiously, he did not pay tribute to the enlisted men even though the division suffered heavier

Brigadier-General James Samuel Wadsworth (*seated, right*) and his staff. (U.S. National Archives)



FIRST DIVISION

Brigadier-General James Samuel Wadsworth
(division deployed but not engaged on July 3)

FIRST BRIGADE (The Iron Brigade)

Colonel William Wallace Robinson

- 19th Regiment Indiana Volunteer Infantry
(Total casualties: 210)
- Colonel Samuel J. Williams
- 24th Regiment Michigan Volunteer Infantry
(Total casualties: 363)
- Captain Albert Marsall Edwards
- 2nd Wisconsin Infantry Regiment
(Total casualties: 233)
- Major John Mansfield
- 6th Wisconsin Infantry Regiment
(Total casualties: 168)
- Lieutenant-Colonel Rufus R. Dawes
- 7th Wisconsin Infantry Regiment
(Total casualties: 178)
- Major Mark Finnicum

SECOND BRIGADE

Brigadier-General Lysander Cutler

- 7th Regiment Indiana Volunteer Infantry
(Total casualties: 10)
- Colonel Ira Glanton Grover
- 76th Regiment New York State Volunteers
(Cortland Regiment) (Total casualties: 234)
- Captain John Elihu Cook
- 84th Regiment New York State Volunteers
(14th Brooklyn Militia) (Total casualties: 217)
- Colonel Edward Brush Fowler
- 95th Regiment New York State Volunteers
(Warren Rifles) (Total casualties: 115)
- Major Edward Pye
- 147th Regiment New York State Volunteers
(Oswego Regiment) (Total casualties: 296)
- Major George Harney
- 56th Regiment Pennsylvania Volunteer Infantry
(Total casualties: 130)
- Colonel John William Hoffman

casualties, 299 killed, 1,229 wounded, and 627 missing or captured, than any other in the Federal army.

Gettysburg shattered the great Iron Brigade. It never recovered from the 1,153 losses it suffered at the battle. War weary, diluted with less willing soldiers, the Iron Brigade would never perform so well again.

Cutler's 2nd Brigade lost about 1,000 more men than its sister brigade. It too could never again display such valour. As for the divisional commander, after Gettysburg, Wadsworth left the army and was absent for eight months. Gettysburg proved to be his only significant combat assignment. He returned to the army to meet his death in the Wilderness on May 6, 1864, while in command of a division of V Corps.

I Corps – 2nd Division

The end of battle on July 1 found only about half of the 2nd Division answering roll call. About 1,000 officers and men were prisoners. During July 2 the division remained in reserve behind Cemetery Hill. The next day, the division was again in reserve where it endured 'a terrific artillery fire' during the rebel bombardment. At the climax of the great

Brigadier-General John Cleveland Robinson and his men did not participate in combat after his skilled work on July 1. As a divisional commander, he personally led his men to the attack at Spotsylvania and lost his leg to a bullet.

(U.S. National Archives)



SECOND DIVISION

Brigadier-General John Cleveland Robinson
(division deployed but not engaged on July 3)

FIRST BRIGADE

Colonel Peter Lyle/

Colonel Richard Coulter

16th Regiment Maine Volunteer Infantry

(Total casualties: 232)

Colonel Charles William Tilden

13th Regiment Massachusetts Volunteer Infantry

(Total casualties: 185)

Lieutenant-Colonel Nathaniel Walter Batchelder

94th Regiment New York State Volunteers

(Sacket's Harbor Regiment) (Total casualties: 245)

Major Samuel A. Moffett

104th Regiment New York State Volunteers

(Wadsworth Guards) (Total casualties: 194)

Colonel Gilbert G. Prey

11th Regiment Pennsylvania Volunteer Infantry

(108th Volunteers) (Total casualties: 127)

Captain John B. Overmyer

107th Regiment Pennsylvania Volunteer Infantry

(Total casualties: 165)

Captain Emanuel D. Roath

SECOND BRIGADE

Brigadier-General Henry Baxter

12th Regiment Massachusetts Volunteer Infantry

(Total casualties: 119)

Lieutenant-Colonel David Allen, Jr.

83rd Regiment New York State Volunteers

(9th New York Militia) (Total casualties: 82)

Lieutenant-Colonel Joseph Anton Moesch

97th Regiment New York State Volunteers

(3rd Oneida Regiment) (Total casualties: 126)

Major Charles B. Northrup

88th Regiment Pennsylvania Volunteer Infantry

(Total casualties: 110)

Captain Henry Whiteside

90th Regiment Pennsylvania Volunteer Infantry

(19th Volunteers) (Total casualties: 93)

Major Alfred Jacob Sellers/

Colonel Peter Lyle

Confederate charge, corps commander Newton ordered Robinson to bring the division forward to occupy a position on the right of II Corps. By the time the division arrived, the Confederates were in retreat.

Total losses for the division were high: 9 officers and 82 men killed; 68 officers and 548 men wounded, 52 officers and 931 men captured or missing. Robinson praised his men: 'No soldiers ever fought better, or inflicted severer blows upon the enemy.'

Robinson himself had performed well in his first significant test as divisional commander. Plunged into a tactically confusing situation on July 1, against a foe who outnumbered his division, his command had repelled a succession of furious charges. Both his subordinates and his superiors praised his leadership. When the army was reorganised in 1864, Robinson was kept in divisional command. His loss of a leg at Spotsylvania disabled him for further field duty.

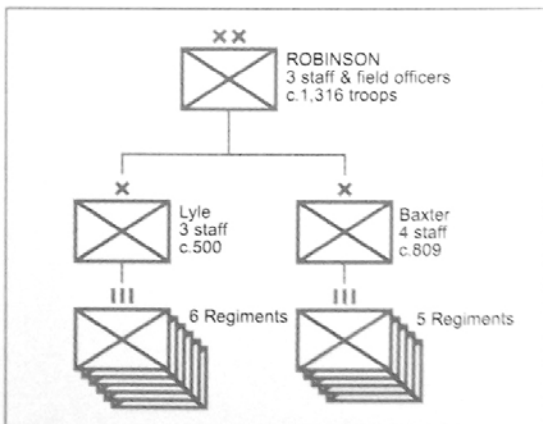



When the division retired to Cemetery Hill and Culp's Hill on July 1, it had only about one-third of its strength. The division had fought hard and suffered accordingly. On July 2 the division rested, in reserve, behind Cemetery Hill until dusk, when it marched to Hancock's assistance.

The division slept in position on the left-centre of the Federal line on Cemetery Ridge, with the 16th Vermont thrown forward on picket duty. The Vermont regiments, along with the 20th New York and 151st Pennsylvania, held the front line during the

Major-General Abner Doubleday, stung by Meade's decision to replace him with Newton after his able performance at corps command on July 1, left the army after Gettysburg never to return.

(U.S. National Archives)



THIRD DIVISION Major-General Abner Doubleday

FIRST BRIGADE

Brigadier-General Thomas Algeo Rowley

SECOND BRIGADE (The Bucktail Brigade)

Colonel Edmund Lovell Dana

143rd Regiment Pennsylvania Volunteer Infantry
(Total casualties: 253)

Lieutenant-Colonel John Dunn Musser

149th Regiment Pennsylvania Volunteer Infantry
(Total casualties: 336)

Captain James Glenn

150th Regiment Pennsylvania Volunteer Infantry
(Total casualties: 264)

Captain Cornelius C. Widdis

THIRD BRIGADE

Brigadier-General George Jerrison Stannard

3rd DIVISION HEADQUARTERS

PROVOST GUARD

Co. D, 149th Regiment Pennsylvania Volunteer Infantry

Colonel Walton Dwight

60 troops present for duty equipped

FIRST DIVISION Major-General Abner Doubleday

1st Brigade – c.468 troops

2nd Brigade – c.470 troops

3rd Brigade – c.1,944 troops

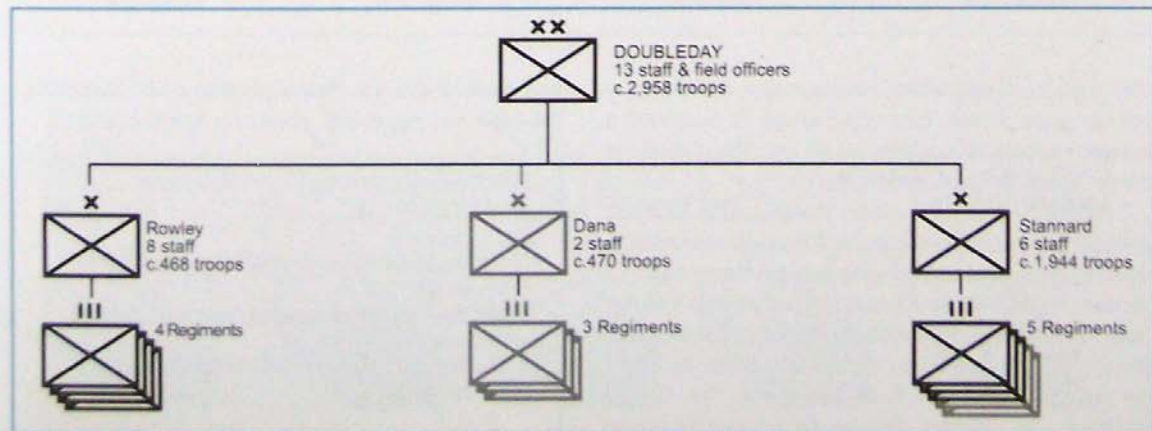

I Corps – 3rd Division – 1st Brigade

After his drunken performance on July 1, Brigadier-General Rowley sobered up enough to resume command on July 2 and 3. His brigade remained in reserve on July 2. On July 3, the

Following his inept, drunken performance at Gettysburg, Brigadier-General Thomas Algeo Rowley received re-assignment to a Maine draft board within a week of battle's end. (MARS)

**FIRST BRIGADE**

Brigadier-General Thomas Algeo Rowley

80th Regiment New York State Volunteers (Ulster Guard)
(Total casualties: 170)
Colonel Theodore Burr Gates
121st Regiment Pennsylvania Volunteer Infantry
(Total casualties: 179)
Colonel Chapman Biddle
142nd Regiment Pennsylvania Volunteer Infantry
(Total casualties: 211)
Lieutenant-Colonel Alfred Brunson McCalmont
151st Regiment Pennsylvania Volunteer Infantry
(Total casualties: 337)
Captain Walter L. Owens

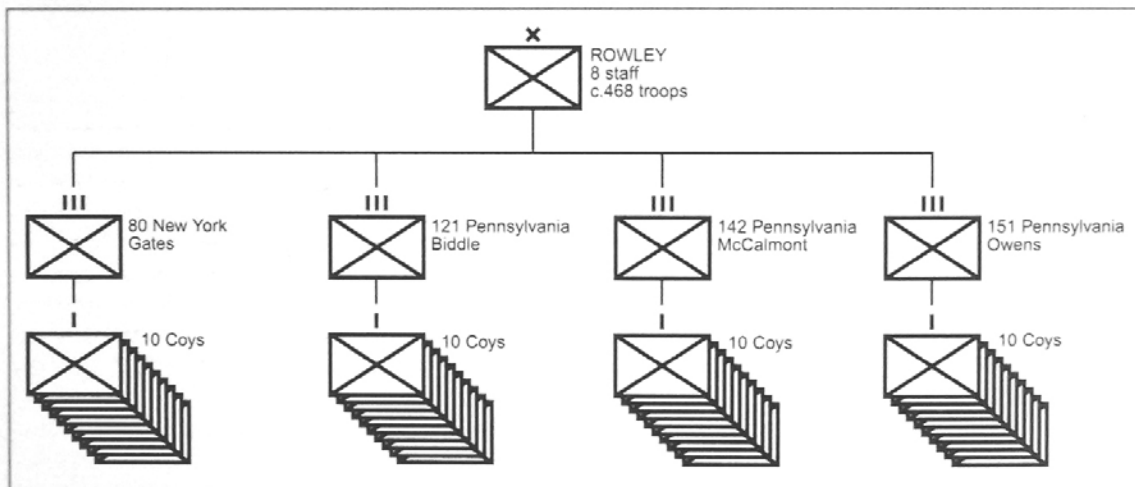

80th New York and 151st Pennsylvania composed a demi-brigade in the front line, where it occupied a position about 300 yards south of the Copse of Trees during the bombardment.

The 80th New York joined the Vermont soldiers, advancing against the flank of the Confederate assault column and closing to engage in hand-to-hand combat. The 151st Pennsylvania fired volleys into the flank of Kemper's Brigade when the Confederate infantry charged and then moved out of line to follow the rebels who were flowing towards the Copse of Trees. Its soldiers helped recapture the guns

belonging to the 1st New York Battery B. Meanwhile, the other two regiments were only lightly engaged.

**80th Regiment New York State Volunteers
(Ulster Guard)**

Cos. A through K.

121st Regiment Pennsylvania Volunteer Infantry

Cos. A through K.

142nd Regiment Pennsylvania Volunteer Infantry

Cos. A through K.

151st Regiment Pennsylvania Volunteer Infantry

Cos. A through K.

I Corps – 3rd Division – 3rd Brigade

The Vermont Brigade

The 1,950 Vermont soldiers of the 3rd Brigade arrived at Gettysburg at twilight on July 1. The next day the brigade remained in reserve behind Cemetery Ridge until near darkness, when it was called upon to help repel Wright's assault. Several regiments deployed in line under artillery fire. Death seemed to come at random. One shell, recalled an officer, 'came through the ranks about four feet to my right killing two men, one or two others wounded'. The Vermont men advanced but by that time the Confederate infantry were already in retreat.

The Executive Officer of the 16th, Lieutenant-Colonel Charles Cummings, was in charge of the picket line. He stationed three companies as pickets with two in support while the rest of the regiment



Brigadier-General George Jerrison Stannard and his men earned his superior's praise on July 3. Hancock said the Vermonters 'behaved with spirit ... were well ordered and well and vigorously handled by General Stannard'.
(U.S. National Archives)

THIRD BRIGADE

Brigadier-General George Jerrison Stannard/
Colonel Francis Voltaire Randall

- 12th Regiment Vermont Volunteers
(Guarding trains – not engaged at Gettysburg)
Colonel Asa P. Blunt
- 13th Regiment Vermont Volunteers
(Total casualties: 123)
Colonel Francis Voltaire Randall/
Major Joseph J. Boynton/
Lieutenant-Colonel William D. Munson
- 14th Regiment Vermont Volunteers
(Total casualties: 107)
Colonel William Thomas Nichols
- 15th Regiment Vermont Volunteers
(Guarding trains – not engaged at Gettysburg)
Colonel Redfield Proctor
- 16th Regiment Vermont Volunteers
(Total casualties: 119)
Colonel Wheelock Graves Veasey

remained back on Cemetery Ridge. He was in the line all night. The Yankees and rebels agreed to a truce so both sides could hunt for their wounded. Cummings later recalled to his wife, 'Stretchers and ambulances were running all night ... The groans of the wounded were mournful and sad in the extreme. Added to this was the confidence that in the morning the terrible

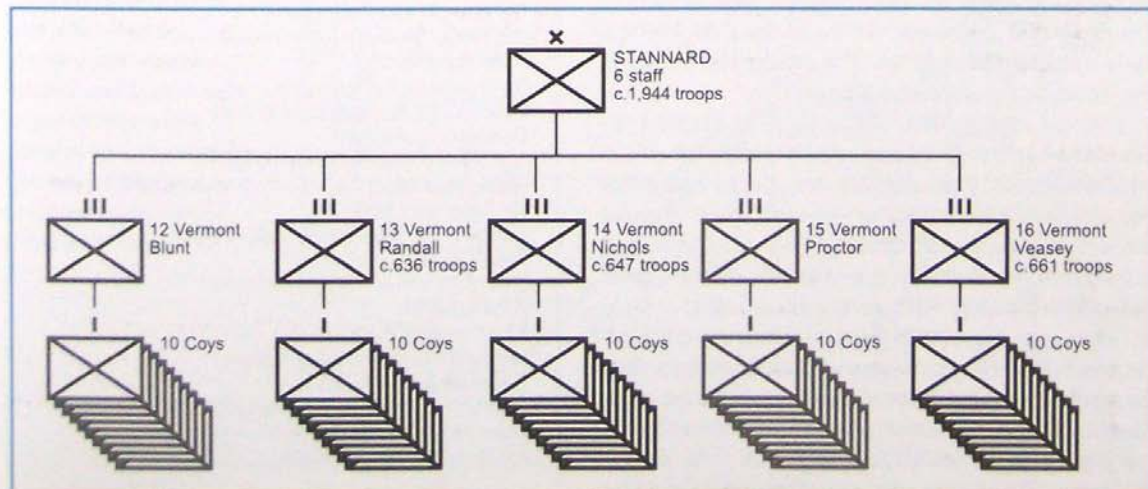

12th Regiment Vermont Volunteers

Cos. A through K.

13th Regiment Vermont Volunteers

Cos. A through K.

14th Regiment Vermont Volunteers

Cos. A through K.

15th Regiment Vermont Volunteers

Cos. A through K.

16th Regiment Vermont Volunteers

Cos. A through K.

conflict would be renewed, and you can well imagine that I was thoughtful.' Cummings' foreboding proved justified. On July 3 the brigade would play a salient role in the defence of the Union centre.

I Corps Artillery Brigade

Because the batteries of I Corps and XI Corps were intermixed, to simplify control, the Chief of Artillery for I Corps, Colonel Charles S. Wainwright, assumed command of all guns on Cemetery Hill east of the Baltimore Pike. His counterpart in XI Corps commanded those west of the Pike.

On July 3 the various batteries occupied the same positions as the previous day. Four Napoleons of Battery B, 4th Artillery (two had been disabled by loss of pointing rings), were adjacent to the Baltimore Pike on Cemetery Hill, in a position to command the approaches from town. To its left was an XI Corps battery. Next was Battery B, 1st Pennsylvania Light Artillery, and then Battery L, 1st New York Light Artillery. This gave I Corps 13 3-inch rifles to bear to the north and northwest. Three of the 2nd Maine's guns had been dismantled. The other three occupied the far left of the Cemetery Hill gun line.

The six 12-pounder Napoleons of Battery E, 5th Maine Light Artillery, occupied a small knoll on the saddle between Cemetery Hill and Culp's Hill. From this position, later known as Stevens' Knoll, it could deliver an oblique fire against Seminary Ridge and a close-range flanking fire against infantry who assaulted Cemetery Hill's northeast face.

There was no serious attack against the batteries on July 3. According to Wainwright, 'The batteries fired occasional shots at bodies of the enemy's troops in the distance during the morning, and joined in the general artillery engagement in the afternoon. The fire of the enemy's batteries was noticed to be much less

Congressional Medals of Honor

Name: George G. Benedict**Rank:** 2nd Lieutenant**Unit:** 12th Regiment Vermont Volunteers**Date:** July 3 1863**Citation:** Passed through a murderous fire of grape and canister in delivering orders and re-formed the crowded lines.**Name:** Wheelock Graves Veasey**Rank:** Colonel**Unit:** 16th Regiment Vermont Volunteers**Date:** July 3 1863**Citation:** Rapidly assembled his regiment and charged the enemy's flank; charged front under heavy fire, and charged and destroyed a Confederate brigade, all this with new troops in their first battle.

accurate than on the previous day.' He concluded by saying that during the three days' fight, 'all the officers and men performed their duty to my perfect satisfaction'. The artillery brigade lost 9 killed, 86 wounded, and 11 missing during the battle.

I CORPS ARTILLERY BRIGADE Colonel Charles S. Wainwright

Battery B, 2nd Maine Artillery

Captain James Abram Hall

(95 troops present for duty equipped)

(Total casualties: 18)

3 x 3-inch rifled guns

Battery E, 5th Maine Light Artillery

Lieutenant Edward N. Whittier

(98 troops present for duty equipped)

(Total casualties: 23)

6 x 12-pounder Napoleon guns

Battery L, 1st New York Light Artillery

Lieutenant George Breck

(c.119 troops present for duty equipped)

(Total casualties: 17)

5 x 3-inch rifled guns

Battery B, 1st Pennsylvania Light Artillery

Captain James Harvey Cooper

(101 troops present for duty equipped)

(Total casualties: 12)

4 x 3-inch rifled guns

Battery B, 4th United States Artillery

Lieutenant James Stewart

(c.87 troops present for duty equipped)

(Total casualties: 36)

2 x 12-pounder Napoleon guns

When Kemper's Brigade, part of Pickett's Division, obliqued in front of Stannard's Brigade, in order to assault the Union centre, the 13th and 16th Vermont Regiments shifted position to deliver enfilade fire. The 16th Vermont then counter-marched to help preel the advance of Lang's and Wilcox's Brigades along Plum Run. Such battlefield manoeuvres under fire were a tremendous achievement, particularly for troops new to combat.

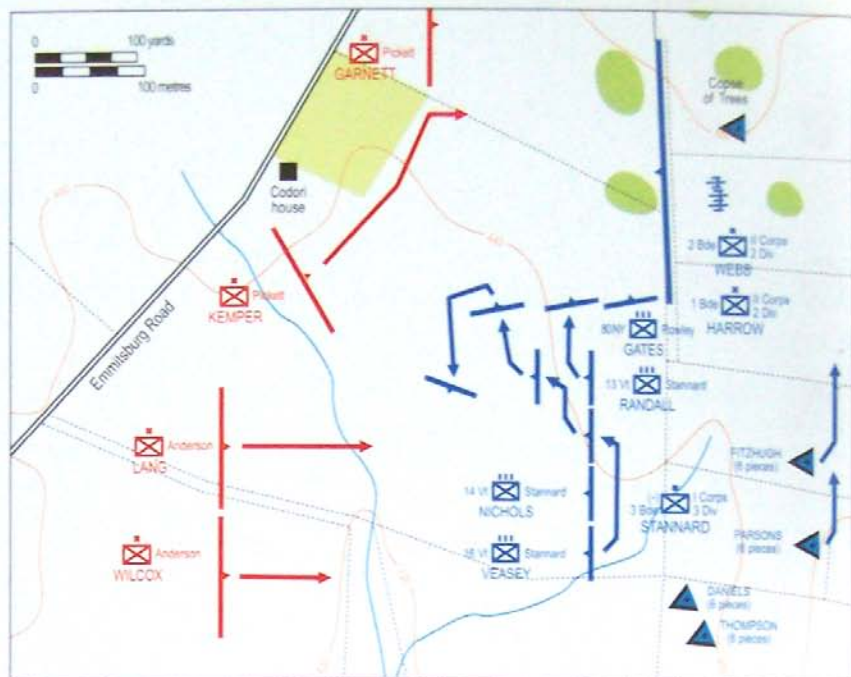

the batteries and right glad were we to see them. They came out in front, protected by their shells ... and deployed handsomely in line. On they came directly toward my picket line but the grape and canister from our batteries and the shots now fired from my picket now acting as skirmishers warned them of the hazard of that route. Then they turned and marched by their left flank.' At the sound of a bugle call, the Vermont skirmishers retired and re-formed.

After the advance of Kemper's Brigade drove back the skirmishers of the 16th Vermont, the rebels approached the 14th Vermont, which was partially concealed in the bushes and rocks at the base of Cemetery Ridge. One wing of the 14th Vermont rose to its feet. Before the Virginians could react, Stannard ordered the other wing, as well as the 13th Vermont, to rise and open fire. The first volley seemed to knock down the entire rebel front rank. Colonel Randall of the 13th Vermont reported, 'We continued to pour in our fire as best we could, and very soon the charging column seemed to slacken and nearly halt.' The Confederates shrank from the fire and converged toward the right of the Vermont soldiers.

In one of the day's great tactical decisions, Stannard ordered the Vermonters to change front in order to flank Kemper from the south. The

13th Vermont double-quickd about 100 yards forward and then Colonel Randall ordered, 'Change front, forward on first company.' The regiment pivoted as if on a drill-field and then double-quickd towards the exposed Confederate flank. General Doubleday then appeared, to encourage the regiment, and to assure Randall that the flank attack would be a success. Colonel Gates, who commanded a demi-brigade comprising the 151st Pennsylvania and 80th New York, conformed to this movement. Gates reported, 'As the second [Confederate] line received our fire, it began to oblique to the left, and finally ... all flanked to the right and moved forward in one line of battle, firing rapidly. Perceiving that the design was to break through our left centre ... I moved my command by the right flank ... corresponding with the enemy's movements, and pouring a continuous fire into his ranks as we advanced.'

As the 80th New York and 13th Vermont continued to assail the enemy flank, five companies of the 16th Vermont moved up to extend their line. The New Yorkers were closest to the enemy. As they approached the southern side of the Codori orchard fence they charged into the disordered Confederate mass. The New Yorkers in the front rank waded in with clubbed muskets. The men behind them fired

0400 hrs	0500	0600	0800	1000	1200	1300	1400	1500	1600	1700	1800
pages 75-76						35-4 & 91-95		17-19			90



Following the rebel bombardment, an additional five Union batteries reinforced Cemetery Ridge before the Confederate infantry charged. (U.S. National Archives)

whenever they saw an opportunity. After perhaps five minutes of intense close-range fighting, the Confederates in front of the 80th New York yielded. Many lay down to avoid being hit by their own artillery fire, which continued to sweep the ground. Someone yelled for them to put their hands up and surrender. Rather than risk being shot in the back as they retired, scores of men dropped their weapons, raised their hands, and passed through the Union line to safety. As Pickett's survivors limped back towards Seminary Ridge, General Stannard saw two Confederate brigades, Lang's and Wilcox's, advancing towards the position the Vermonters had recently vacated. When the Confederates passed the Emmitsburg Road, Stannard wheeled the 16th Vermont about and marched south. Meanwhile, the 14th Vermont, which had maintained its position facing west, punished the advancing Confederates with accurate musketry fire. The 16th encountered Lang's Florida Brigade on the marshy ground of Plum Run. Colonel Veazey requested permission from Stannard to charge. Perceiving that a charge would be across the front of the 14th Vermont, Stannard hesitated, then acceded. The charge of the 16th Vermont routed Lang's Brigade. The Vermonters gleefully scooped up

handfuls of prisoners as well as the colours of the 2nd Florida and 8th Virginia. A shell fragment struck Stannard, but he remained in command. Already Wilcox had decided to withdraw. His decision ended the Confederate attempt to storm the Union centre.

In his official report Stannard related how his brigade's complicated movements were executed 'in an open field, under a very heavy fire of shell, grape, and musketry, and they were performed with the promptness and precision of battalion drill'. Later Hancock praised Stannard and his command, saying that Stannard 'did not hesitate to put them in front of the fight, and to keep them there until the battle was decided'.

Doubleday called the brigade's performance perhaps the most brilliant feat of the war. The brigade of nine-month men had fought superbly in their first battle. They also benefited from fine leadership by Hancock, Doubleday, Stannard and their regimental colonels.

I Corps' Casualties at Gettysburg
July 3 1863

Infantry killed or wounded 266
 Infantry missing/captured 10
 Artillery killed or wounded 13
 Artillery missing/captured 0

0400 hrs	0500	0600	0800	1000	1200	1300	1400	1500	1600	1700	1800
	pages 75-76					35-4 & 91-95	17-19			90	

THE ARMY OF THE POTOMAC



II CORPS

On July 2, Major-General Hancock had been very active as he helped stop Longstreet's flank attack. Such was Meade's faith in him that, when Sickles fell with a disabling wound, Meade placed Hancock in command of both his own II Corps and of III Corps. Hancock improvised an ultimately successful defence, at times directing individual regiments, such as the 1st Minnesota, into position.

During July 2, II Corps occupied Cemetery Ridge until late afternoon when Longstreet's assault began. Its 1st Division counter-attacked aggressively and was routed from the field with heavy losses. Elements of



On learning of Major-General Winfield Scott Hancock's serious wound on July 3, Meade ordered: 'Say to General Hancock that I regret exceedingly that he is wounded and that I thank him for the Country and for myself for the service he has rendered today.'
(U.S. National Archives)

II CORPS

Major-General Winfield Scott Hancock
Brigadier-General Alexander Hays
6 Staff and Field Officers

First Division

Brigadier-General John Curtis Caldwell

Second Division

Brigadier-General John F. Gibbon/
Brigadier-General William F. Harrow

Third Division

Brigadier-General Alexander Hays

II Corps Artillery

Captain John G. Hazard

II CORPS HEADQUARTERS

ESCORT

Cos. D & K, 6th New York Volunteer Cavalry Regiment
Captain Riley Johnson
64 troops present for duty equipped

the 2nd Division engaged, with that division's 1st Brigade taking heavy losses. After fighting on the left flank, when a dusk assault exploded against Cemetery Hill, Hancock sent two Pennsylvania regiments from the 2nd Division to help repel the rebels on the right flank. Within the 3rd Division, only the 3rd Brigade entered the main fight on July 2, when it launched a fine counter-attack.

Taken as a whole, II Corps had served in a fire brigade role, sending forces ranging from individual regiments all the way up to a full division to help other sectors of the field. Losses were heavy enough, particularly within Caldwell's Division, that when Hancock reassembled the corps, he found that it required every available man in order to cover the ground held at the start of July 3. Overnight, soldiers improved their positions and the artillery was resupplied.

During Meade's council of war on the evening of July 2, Hancock doubted the practicality of a possible retreat. He advised that the army improve its positions and remain on the defensive. He also worried what Lee might do, since remaining on the defensive gave the Confederates the initiative.

At first light on July 3, rebel sharpshooters, who had re-occupied the Bliss barn during the night, opened a galling fire. A sharp skirmish duel began. Back on Cemetery Ridge, Hancock was literally and figuratively above the fray. He later reported, 'The early morning passed in comparative quiet along our front ... From 11 a.m. until 1 p.m. there was an ominous stillness. About 1 o'clock ... the enemy opened upon our front with the heaviest artillery fire I have ever known.'

II CORPS — GETTYSBURG — July 3

xxx
 HANCOCK
 6 Staff & Field Officers
 c.9,040 troops

 6 NY
 c.64 troops

xx
 Caldwell
 7 staff & field officers
 c.2,172 troops

xx
 Hays
 8 staff & field officers
 c.3,110 troops

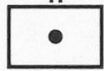
ii
 Hazard
 30 pieces
 c.586 troops

 53 Pa
 c.70 troops

 116 Pa
 c.32 troops

ii
 10 NY
 c.98 troops

x
 McKeen
 3 staff
 c.535

x
 Fraser
 4 staff
 c.660

x
 Carroll
 7 staff
 c.860

 Provost
 c.36

x
 Sherrill
 2 staff
 c.1,000







x
 Smyth
 2 staff
 c.1,105



x
 Kelly
 2 staff
 c.330

x
 Brooke
 1 staff
 c.535





xx
 Gibbon
 6 staff & field officers
 c.3,087 troops

 1 Minn
 c.56 troops

 1 Massachusetts
 Sharpshooters
 c.42 troops

x
 Harrow
 3 staff
 c.1,127

x
 Webb
 3 staff
 c.1,123

x
 Hall
 2 staff
 c.732







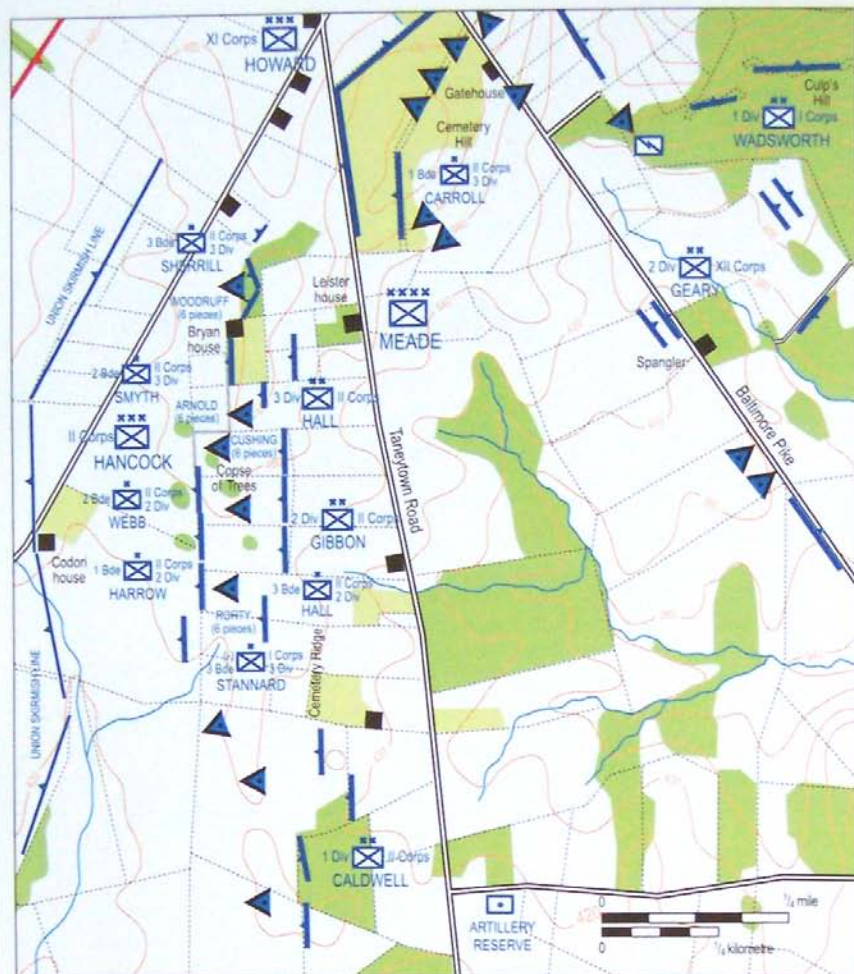

II Corps defended Cemetery Ridge, the point Lee chose to attack in a final effort to win the battle. Some of the regiments had suffered severely the day before, and consequently occupied a narrow frontage. The need to keep rebel marksmen at a respectful distance required a heavy skirmish line. During the early morning some corps troops were drawn into the fight for the Bliss barn. Other troops laboured to improve their position. Most notably, soldiers of the 1st Delaware and 12th New Jersey collected numerous discarded muskets so they would be able to maintain a continuous fire when the rebels charged.

II Corps – 1st Division



At around 1700 hrs on July 2, the 1st Division moved from its position in the middle of Cemetery Ridge to support Sickles in the Wheatfield. It proceeded to mount the Army of the Potomac's only co-ordinated, division-sized counter-attack at Gettysburg. It drove three rebel brigades back in disorder only to have other enemy forces appear suddenly on its right flank and rear. The division broke badly. Later, General Sykes told Hancock that it had fought poorly. Caldwell however reported, 'The division on the afternoon of the 2d fought with its accustomed gallantry, and performed everything that could be expected of either officers or men. The large number of



Brigadier-General John C. Caldwell and his division arrived on the battlefield on July 2. Later that day, he presided ably over a co-ordinated attack by his four brigades, but lost control of his men when McLaws routed them. During July 3 the division was not engaged. (U.S. National Archives)

its killed and wounded attest to its desperate valor.' The division suffered almost all of its 1,275 losses on July 2, including 18 officers and 168 men killed; about 82 officers and 798 men wounded; and 6 officers and 202 men captured or missing.

On July 3 the division was back on Cemetery Ridge, where it was so depleted that it could deploy only a single line. The soldiers threw up breastworks which successfully protected them during the rebel artillery bombardment. It lost only one killed and a few wounded on July 3.

Caldwell blamed the July 2 failure of adjacent formations for allowing the rebels to drive out his division. Corps commander Hancock did not share Caldwell's view. The fact that it had virtually routed and did not return to Cemetery Ridge until after dark annoyed him. He blamed Caldwell for the division's misfortune and later demanded an investigation. The investigation exonerated Caldwell and noted that no troops on the field

FIRST DIVISION HEADQUARTERS

PROVOST GUARD

Cos. A, B and K,

53rd Regiment Pennsylvania Volunteer Infantry

Lieutenant-Colonel Richards McMichael

70 troops present for duty equipped

Co. B,

116th Regiment Pennsylvania Volunteer Infantry

Major St. Clair Agustin Mulholland

32 troops present for duty equipped

had done better than the 1st Division. However, this failed to assuage Hancock, who removed Caldwell from divisional command when the army reorganised in March 1864.

FIRST DIVISION

Brigadier-General John Curtis Caldwell

(division deployed but not engaged on July 3)

FIRST BRIGADE

Colonel Henry Boyd McKeen

5th Regiment New Hampshire Volunteers

(Total casualties: 80)

Lieutenant-Colonel Charles Edward Hapgood

61st Regiment New York State Volunteers

(Total casualties: 62)

Lieutenant-Colonel Knut Oscar Broady

81st Regiment Pennsylvania Volunteer Infantry

(Total casualties: 62)

Lieutenant-Colonel Amos Stroh

148th Regiment Pennsylvania Volunteer Infantry

(Total casualties: 125)

Lieutenant-Colonel Robert McFarlane

THIRD BRIGADE

Lieutenant-Colonel John Fraser

52nd Regiment New York State Volunteers

(Total casualties: 38)

Captain William Scherrer

57th Regiment New York State Volunteers

(Total casualties: 34)

Lieutenant-Colonel Alford B. Chapman

66th Regiment New York State Volunteers

(Total casualties: 44)

Major Peter Adolph Nelson

140th Regiment Pennsylvania Volunteer Infantry

(Total casualties: 241)

Lieutenant-Colonel John Fraser

FOURTH BRIGADE

Colonel John Rutter Brooke

27th Regiment Connecticut Infantry Volunteers

(Total casualties: 37)

Major James H. Coburn

2nd Regiment Delaware Volunteers

(Total casualties: 84)

Colonel William P. Baily

64th Regiment New York State Volunteers

(1st Cattaraugus Regiment)

(Total casualties: 98)

Major Leman W. Bradley

53rd Regiment Pennsylvania Volunteer Infantry

(Total casualties: 80)

Lieutenant-Colonel Richards McMichael

145th Regiment Pennsylvania Volunteer Infantry

(Total casualties: 90)

Colonel Hiram Loomis Brown

SECOND BRIGADE (The Irish Brigade)

Colonel Patrick Kelly

28th Regiment Massachusetts Volunteer Infantry

(Total casualties: 100)

Colonel Richard Byrnes

63rd Regiment New York State Volunteers

(Total casualties: 23)

Captain Thomas Touhy

69th Regiment New York State Volunteers

(Total casualties: 25)

Lieutenant James Joseph Smith

88th Regiment New York State Volunteers

(Total casualties: 28)

Captain Denis Francis Burke

116th Regiment Pennsylvania Volunteer Infantry

(Total casualties: 22)

Major St. Clair Agustin Mulholland

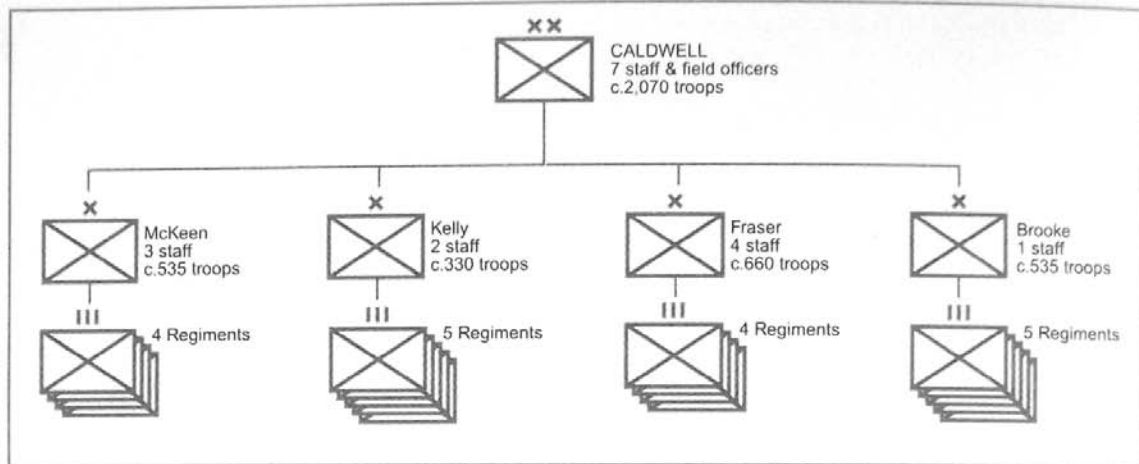

II Corps – 2nd Division



On July 2 various regiments from the 2nd Division were used to meet Confederate attacks all along Cemetery Ridge. The division's commander, Brigadier-General John Gibbon, was likewise employed in a stopgap fashion. He ascended to corps command when Hancock became a wing commander due to Sickles' wound. Because he was an acting corps commander, Gibbon attended Meade's council of war during the evening. As the council broke up near midnight, Meade, who was on particularly friendly terms with Gibbon and respected his abilities, took him aside and said, 'If Lee attacks tomorrow, it will be on your front.' Although Meade would partially change his mind the next morning, Hancock and Gibbon took the prophetic warning to heart.

The next day, various senior officers gathered on Cemetery Ridge for lunch. General Newton taunted

SECOND DIVISION

Brigadier-General John F. Gibbon/
Brigadier-General William F. Harrow

1st Brigade – c.1,127 troops
2nd Brigade – c.1,123 troops
3rd Brigade – c.732 troops

Severely wounded on the third day at Gettysburg, Brigadier-General John Gibbon did not return to the field for another eight months. After the war he continued to serve in the army, fighting Indians for more than two decades.

(U.S. National Archives)



Gibbon, calling him 'this young North Carolinian' (although born in Philadelphia Gibbon grew up in North Carolina) and said his promotion to corps command placed him beyond his station. Then, Meade said more seriously, 'General Gibbon, see that all your provost guards are sent to the front after the artillery ceases fire.' Clearly, Meade again expected an assault against Gibbon's position.

2nd DIVISION HEADQUARTERS

PROVOST GUARD

Co. C, 1st Minnesota Volunteer Infantry Regiment

Captain Wilson B. Fennell

56 troops present for duty equipped

1st Co., Massachusetts Sharpshooters

Captain William Plumer/

Lieutenant Emerson L. Bicknell

42 troops present for duty equipped

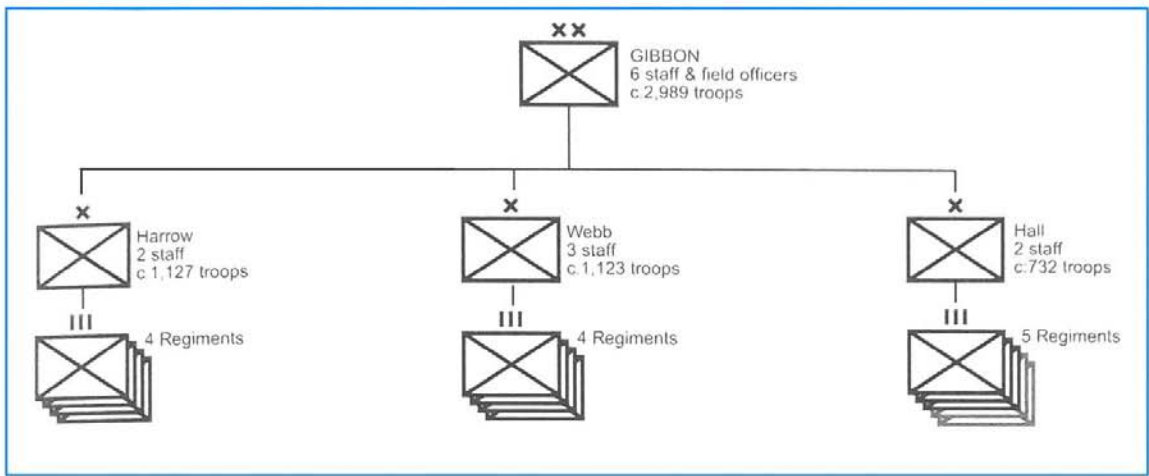

II Corps – 2nd Division – 1st Brigade

The 1st Brigade was heavily engaged on July 2. The 15th Massachusetts and 82nd New York advanced to the Emmitsburg Road to support Sickles. Here they sustained an unequal contest until the rebels poured around their left flank and drove them back with losses including both colonels. The 19th Maine fought an equally desperate combat while supporting a Rhode Island battery. But no Union regiment on the field surpassed the 1st Minnesota.

While Hancock was riding along Cemetery Ridge, he perceived an enemy column advancing towards a gap in the Union line. Hancock ordered the nearest regiment, the 1st Minnesota, to charge the rebel column. It was a sacrificial mission and both Hancock

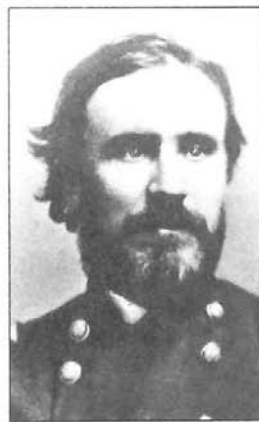

On July 3, Brigadier-General William Harrow conspicuously patrolled in front of the lines to encourage his troops. A captain remarked, 'It would prove disheartening if, as seemed probable, he should be struck down while teaching us to despise the danger.' (MOLLUS-Pennsylvania)

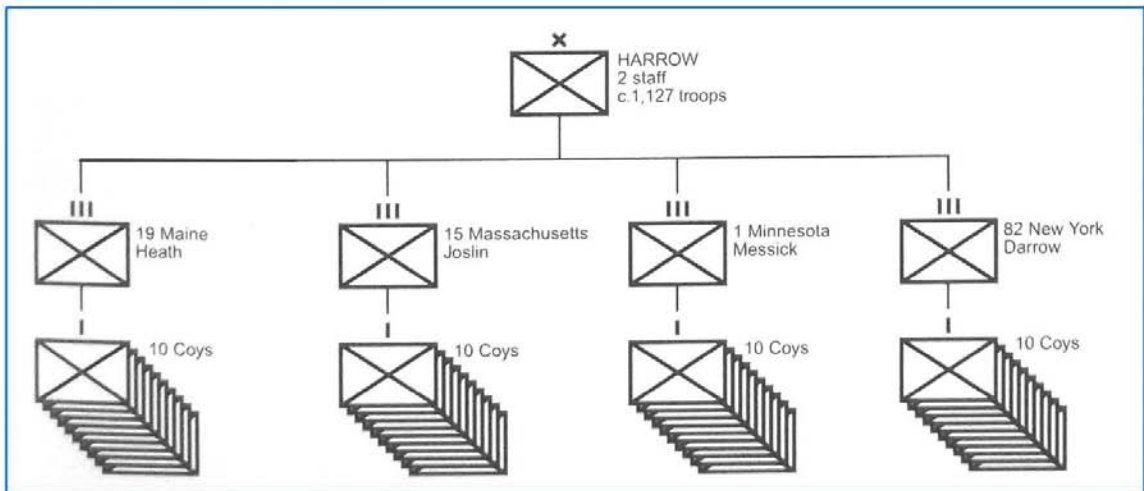

FIRST BRIGADE

Brigadier-General William F. Harrowl
Colonel Francis Edward Heath

19th Regiment Maine Volunteer Infantry
 (Total casualties: 203)
Colonel Francis Edward Heath
Lieutenant-Colonel Henry W. Cunningham
 15th Regiment Massachusetts Volunteer Infantry
 (Total casualties: 148)
Lieutenant-Colonel George C. Joslin
 1st Minnesota Volunteer Infantry Regiment
 (Total casualties: 224)
Captain Nathan S. Messick
Captain Henry C. Coates
 82nd Regiment New York State Volunteers
 (2nd Militia) (Total casualties: 192)
Captain John Darrow

Congressional Medals of Honor

Name: Henry D. O'Brien
Rank: Corporal
Unit: Co. E, 1st Minnesota Volunteer Infantry Regiment
Date: July 3 1863
Citation: Taking up the colors where they had fallen, he rushed ahead of his regiment, close to the muzzles of the enemy's guns, and engaged in the desperate struggle in which the enemy was defeated, and though severely wounded, he held the colors until wounded a second time.

Name: Marshall Sherman
Rank: Private
Unit: Co. C, 1st Minnesota Volunteer Infantry Regiment
Date: July 3 1863
Citation: Capture of flag of 28th Virginia Infantry (C.S.A.).

19th Regiment Maine Volunteer Infantry

Colonel Heath
 Cos. A through K.

15th Regiment Massachusetts Volunteer Infantry

Lieutenant-Colonel Joslin
 Cos. A through K.

1st Minnesota Volunteer Infantry Regiment

Captain Messick
 Cos. A through K.

82nd Regiment New York State Volunteers

Captain Darrow
 Cos. A through K.

and the regimental colonel, William Colvill, Jr., knew it.

Eight companies, numbering 262 men, advanced. Hancock was subsequently to report that they charged 'in handsome style, capturing its colors, and driving it back in disorder'. Colvill described the reality: the regiment went 'down the slope at full speed through the concentrated fire of the two brigades, breaking with the bayonet the enemy's front line as it was crossing the small brook in the low ground (Plum Run). There the remnant of the eight companies nearly surrounded by the enemy held its entire force at bay for a considerable time and till it retired on the approach of the reserve.'

Overwhelmed, survivors of the 1st Minnesota retired up the slope. However, the regiment had purchased an invaluable 10 minutes or so at the cost of 215 men killed and wounded. More than four out of five men who began the charge fell. There were no missing or captured. Badly depleted, the brigade was only able to man a short sector 200 yards south of the Copse of Trees on July 3.

II Corps – 2nd Division – 2nd Brigade**The Philadelphia Brigade**

On July 2 the all-Pennsylvania 2nd Brigade occupied the centre of Cemetery Ridge. Except for skirmishing, it did not engage until 1830 hrs, when Wright's Georgia Brigade charged towards the 1st Rhode Island Artillery, which was deployed just in front of the 69th Pennsylvania. The 69th lay sheltered behind a hastily constructed breastworks made from fence rails and stones. When the Confederates advanced beyond the battery, it received fire from the 69th Pennsylvania. Adjacent regiments moved to support the 69th and then the Yankees counter-attacked. Lieutenant-Colonel



Brigadier-General Alexander Stewart Webb came from a long line of soldiers. The relatively green 28-year-old New Yorker took command of a veteran Pennsylvania brigade just before Gettysburg, and had to prove his courage to his men.
 (Library of Congress)

SECOND BRIGADE

Brigadier-General Alexander Stewart Webb

69th Regiment Pennsylvania Volunteer Infantry
(Total casualties: 137)

Colonel Dennis O'Kane

Captain William Davis

71st Regiment Pennsylvania Volunteer Infantry
(Total casualties: 98)

Colonel Richard Penn Smith, Jr.

72nd Regiment Pennsylvania Volunteer Infantry
(Fire Zouaves) (Total casualties: 192)

Lieutenant-Colonel Theodore Hesser

106th Regiment Pennsylvania Volunteer Infantry
(Total casualties: 64)

Lieutenant-Colonel William Lovering Curry

William Curry of the 106th wrote, 'I advanced my regiment to the crest of the hill, and opened fire upon the enemy. After several volleys, perceiving that we checked his advance, and seeing his lines waver, I ordered bayonets fixed and a charge to be made.' Brigadier-General Alexander Webb reported that the rebels 'halted, wavered, and fell back' pursued by the

106th, 72nd and part of the 71st regiments. The 106th and 72nd chased the enemy all the way to the Emmitsburg Road, capturing about 250 prisoners. The 71st counter-attacked into the Rhode Island battery and captured about 20 more men. Later the 106th and 71st Pennsylvania marched to support XI Corps on Cemetery Hill. Misdirected by a staff officer, the 71st ended up in the woods 500 yards south of Cemetery Hill. Here it became involved in a confusing nocturnal fight on unfamiliar ground. Nearly surrounded, it lost 3 officers and 11 men in this combat. Attacked in flank and rear, Colonel Smith 'immediately ordered my command to retire to the road in my rear [Baltimore Pike] when I returned to camp against orders' about midnight. Many censured Smith's conduct and believed that he deserved a court martial.

XI Corps' commander, General Howard, personally positioned the 106th near the cemetery, where it remained until 4 July. Thus the Philadelphia Brigade was used, like many other II Corps formations on July 2, responding to emergencies and operating without any sort of brigade unity.

69th Regiment Pennsylvania Volunteer Infantry

Colonel O'Kane

Cos. A through K.

71st Regiment Pennsylvania Volunteer Infantry

Colonel Smith

Cos. A through K.

72nd Regiment Pennsylvania Volunteer Infantry

Lieutenant-Colonel Hesser

Cos. A through K.

106th Regiment Pennsylvania Volunteer Infantry

Lieutenant-Colonel Curry

Cos. A through K.

Congressional Medals of Honor

Name: Alexander S. Webb

Rank: Brigadier-General

Unit: II Corps, 2nd Division, 2nd Brigade

Date: July 3 1863

Citation: Distinguished personal gallantry in leading his men forward at a critical period in the contest.

Name: John E. Clopp

Rank: Private

Unit: Co. F, 71st Regiment Pennsylvania Volunteer Infantry

Date: July 3 1863

Citation: Capture of flag of 9th Virginia Infantry, wresting it from the color bearer.

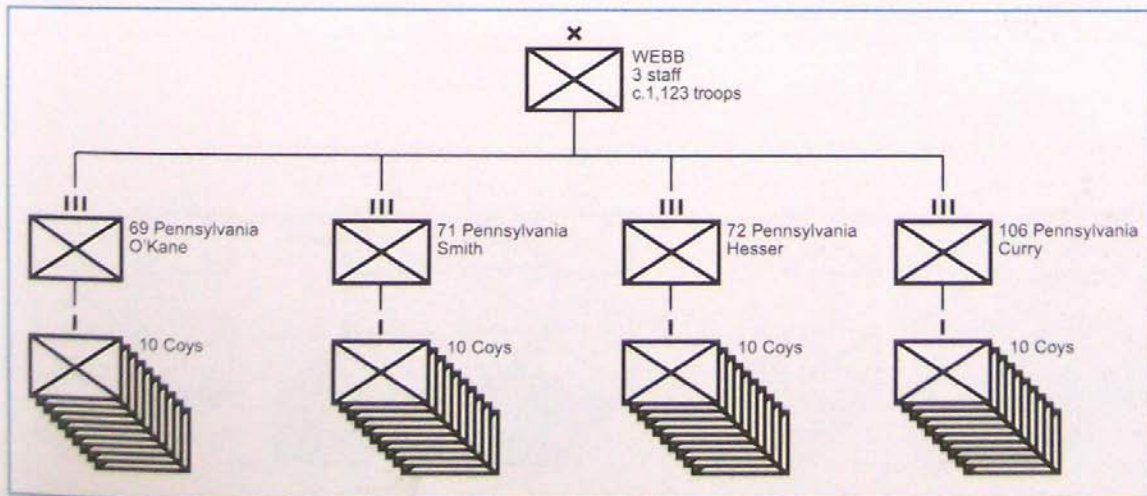

II Corps – 2nd Division – 3rd Brigade

The five regiments that made up the 3rd Brigade arrived on Cemetery Ridge on July 2 having completed a march of about 190 miles without a day's rest. As Sickles' position began to collapse, an order came to send two regiments to assist III Corps. Colonel Hall sent the 42nd New York and 19th Massachusetts. They marched through the fleeing Union troops to form a battle line and deliver several volleys against the surging Confederates. Having lost

THIRD BRIGADE

Colonel Norman Jonathan Hall

19th Regiment Massachusetts Volunteer Infantry

(Total casualties: 77)

Colonel Arthur Forrester Devereux

20th Regiment Massachusetts Volunteer Infantry

(Total casualties: 127)

Colonel Paul Joseph Revere

Lieutenant-Colonel George Macy

Captain Henry L. Abbott

7th Regiment Michigan Volunteer Infantry

(Total casualties: 65)

Lieutenant-Colonel Amos E. Steele, Jr.

Major Sylvanus W. Curtis

42nd Regiment New York State Volunteers

(Tammany Regiment) (Total casualties: 74)

Colonel James Edward Mallon

59th Regiment New York State Volunteers

(Union Guards) (Total casualties: 34)

Captain William McFadden

Congressional Medals of Honor

Name: Joseph H. de Castro

Rank: Corporal

Unit: Co. I, 19th Regiment Massachusetts Volunteer Infantry

Date: July 3 1863

Citation: Capture of flag of 9th Virginia Infantry (C.S.A.), wresting it from the color bearer.

Name: John H. Robinson

Rank: Private

Unit: Co. I, 19th Regiment Massachusetts Volunteer Infantry

Date: July 3 1863

Citation: Capture of flag of 57th Virginia Infantry.

Name: James Wiley

Rank: Sergeant

Unit: Co. B, 59th Regiment New York State Volunteers

Date: July 3 1863

Citation: Capture of flag of a Georgia regiment.

about one-third of their strength, the regiments retired.

At this point Hall perceived a gap in the Union line on his left. On his own initiative he moved several regiments to plug this gap. Hall reported, 'The enemy being now within 30 or 40 yards of the line of this brigade, the men, lying down, poured into him so well-directed a fire that he halted, fell back, and finally broke in great disorder.' The rebels left two colours within 20 yards of the 7th Michigan's front line. The brigade lost about 150 men on July 2.

Although they lacked tools, during the night the

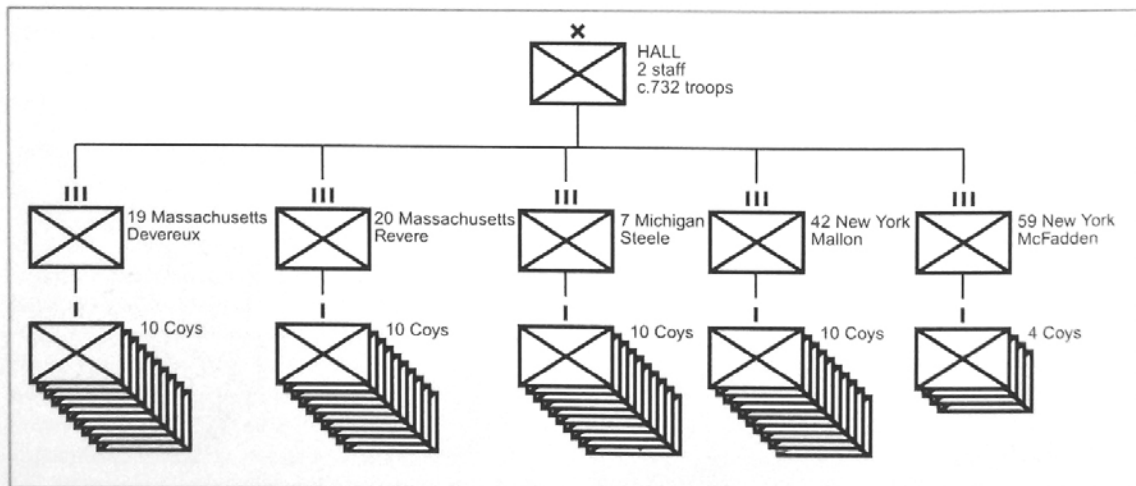

soldiers improved their position with rails, stones and whatever earth they could shift using sticks and boards. This was a paltry defence against the Confederate July 3 bombardment.

On July 3, the 20th Massachusetts, 7th Michigan and 59th New York deployed on the crest of Cemetery Ridge. The other two regiments, which had borne the brunt of the fight on July 2, were in reserve on the brigade's right rear. Hall would again employ his regiments with a sure tactical touch and earn the respect of Gibbon and Webb. Even though he was a West Point graduate, his performance at Gettysburg did not earn him promotion. By the end of the year he had returned to command the 7th Michigan and would not rise above that level again.

II Corps – 3rd Division



After a short march of about three miles along the Taneytown Road, the 3rd Division arrived on Cemetery Ridge. A stone wall just below the crest gave the position a natural fortification. The open fields extending towards Seminary Ridge meant that the supporting artillery would have free play. Even

Brigadier-General Alexander Hays: 'I was fighting for my native state and before I went in I thought of those at home ... If Gettysburg was lost all was lost for them.'

(U.S. National Archives)



THIRD DIVISION HEADQUARTERS

PROVOST GUARD - attached from 2nd Brigade

10th Infantry Battalion

New York State Volunteers

Major George Faulkner Hopper

98 troops present for duty equipped

though its commander, Brigadier-General Alexander Hays, had assumed command only three days before Gettysburg, the division had already learned to

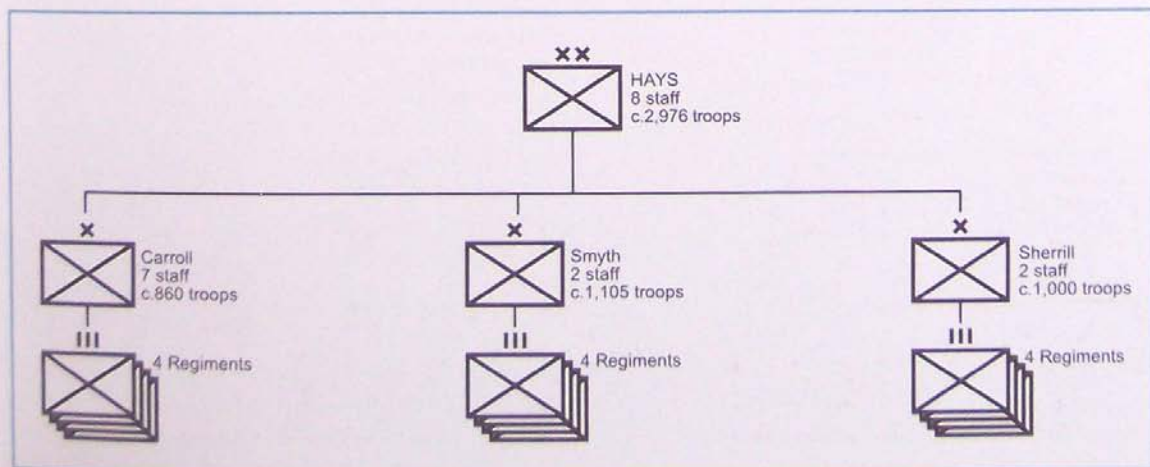

THIRD DIVISION
Brigadier-General Alexander Hays

1st Brigade – c.860 troops
2nd Brigade – c.1,105 troops
3rd Brigade – c.1,000 troops

respect his appreciation of his men. Hays reviled 'scientific leaders' and referred to strategy as 'humbug'.

For the rest of the day only skirmishing disturbed the men. Hays posted a strong line of skirmishers along the Emmitsburg Road, using the 12th New Jersey, 1st Delaware, and 14th Connecticut. Twice they sortied to the Bliss farm buildings to contest that

II Corps – 3rd Division – 1st Brigade

The 1st Brigade deployed on Cemetery Ridge on July 2 at about 0800 hrs. Colonel Samuel Sprigg Carroll sent four companies of his 4th Ohio forward to support the skirmish line. After four hours of skirmishing, he replaced them with two new companies. When the rebels made an advance, Carroll received orders to send the 8th Ohio forward into the fight. The 8th advanced 200 yards to provide a solid skirmish support. Two companies from the regiment continued on to reinforce the two companies of the 4th Ohio. This effort stabilised the skirmish line.

FIRST BRIGADE

Colonel Samuel Sprigg Carroll

PROVOST GUARD

Captain Alfred Craig

36 troops present for duty equipped

14th Regiment Indiana Volunteer Infantry
(Total casualties: 31)
Colonel John Coons
4th Ohio Volunteer Infantry Regiment
(Total casualties: 31)
Lieutenant-Colonel Leonard Willard Carpenter
8th Ohio Volunteer Infantry Regiment
(Total casualties: 102)
Lieutenant-Colonel Franklin Sawyer
7th West Virginia Infantry Regiment
(Total casualties: 47)
Lieutenant-Colonel Jonathan Hopkins Lockwood

position with Confederate skirmishers. The men forming the battle line atop Cemetery Ridge endured sporadic artillery fire during the day.

When Sickles' position fell apart, Hancock ordered Hays' old command, the 3rd Brigade, to the left. Here it fought sternly, and the brigade commander, Colonel George Willard, died from a shell fragment. About half of the division's entire losses for the battle were inflicted upon Willard's brigade on July 2.

Hays reported that daylight of July 3 'was a signal for renewed hostilities, and during the morning was a repetition of the practice of the previous day, excepting that their skirmishers appeared more pertinacious in their assaults'. At 1100 hrs a lull occurred, not to be broken until the Confederate artillery began its great bombardment.

14th Regiment Indiana Volunteer Infantry

Colonel Coons

Cos. A through K.

4th Ohio Volunteer Infantry Regiment

Lieutenant-Colonel Carpenter

Cos. A through K.

8th Ohio Volunteer Infantry Regiment

Lieutenant-Colonel Sawyer

Cos. A through K.

7th West Virginia Infantry Regiment

Lieutenant-Colonel Lockwood

Cos. A through K.

Colonel Samuel Sprigg Carroll is said to have wept when he learned the fate of his old regiment, the 8th Ohio, on July 3. He finally received his long-overdue brigadier's star when he was badly wounded at Spotsylvania the following year. (MARS)



When the main Confederate push came at around 1800 hrs, Hays ordered Carroll to shift the 14th Indiana, 4th Ohio (minus its skirmish companies) and 7th West Virginia to the left to buttress the 2nd

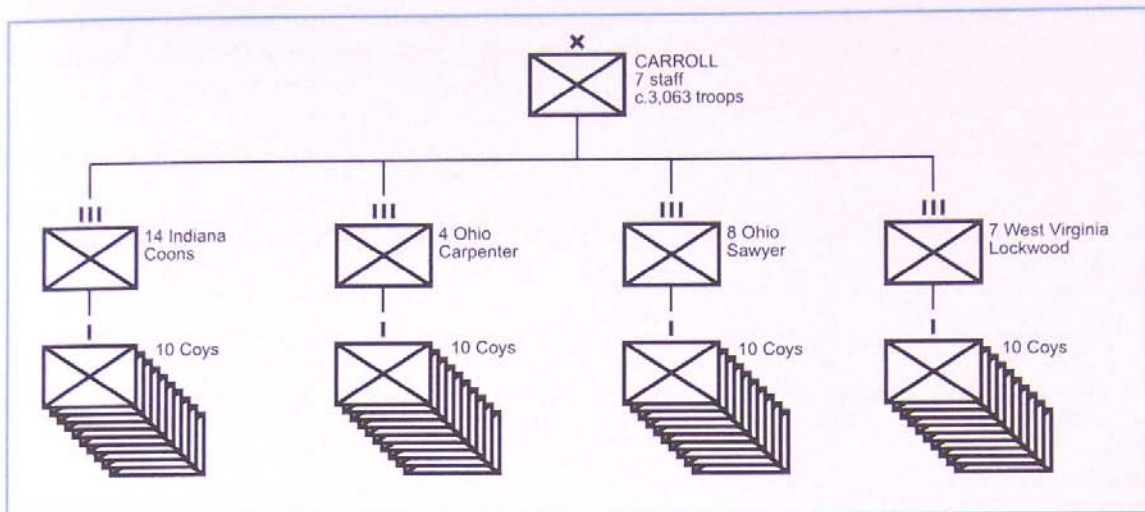

Brigade. This movement occurred 'under a heavy discharge of shot, shell, and musketry.' So confusing was the fight that within minutes of entering this new position, Carroll received orders to return to his original position. Finally, these three regiments moved to Cemetery Hill to assist XI Corps, where they would remain on July 3.

Congressional Medal of Honor

Name: James Richmond
Rank: Private
Unit: Co. F, 8th Ohio Volunteer Infantry Regiment
Date: July 3 1863
Citation: Capture of flag.

II Corps – 3rd Division – 2nd Brigade

Like the 1st Brigade, the 2nd Brigade entered a brisk skirmish beginning about 0800 hrs on July 2. Initially the entire 1st Delaware participated in the action. When the Confederates advanced against the Bliss barn, four companies of the 12th New Jersey counter-attacked. They dislodged the rebel sharpshooters and captured 92 prisoners while suffering 42 men killed and wounded. However, another Confederate push reclaimed the barn. The Yankees

Colonel Thomas Alfred Smyth finally received his promotion to brigadier-general in October 1864. Shot during Lee's final retreat, he was the last Union general of the war to die of a combat wound.

(U.S. National Archives)



SECOND BRIGADE

Colonel Thomas Alfred Smyth
Lieutenant-Colonel Francis Edwin Pierce

14th Regiment Connecticut Infantry Volunteers
 (Total casualties: 66)

Major Theodore Grenville Ellis
 1st Regiment Delaware Volunteers
 (Total casualties: 77)

Captain Thomas B. Hizar
Lieutenant William Smith
Lieutenant John T. Dent
 12th New Jersey Volunteer Infantry Regiment
 (Total casualties: 115)

Major John T. Hill
 108th Regiment New York State Volunteers
 (Total casualties: 102)

Lieutenant-Colonel Francis Edwin Pierce
Successor unknown
 10th Battalion New York State Volunteers
 (Total casualties: 6)

Major George Faulkner Hopper

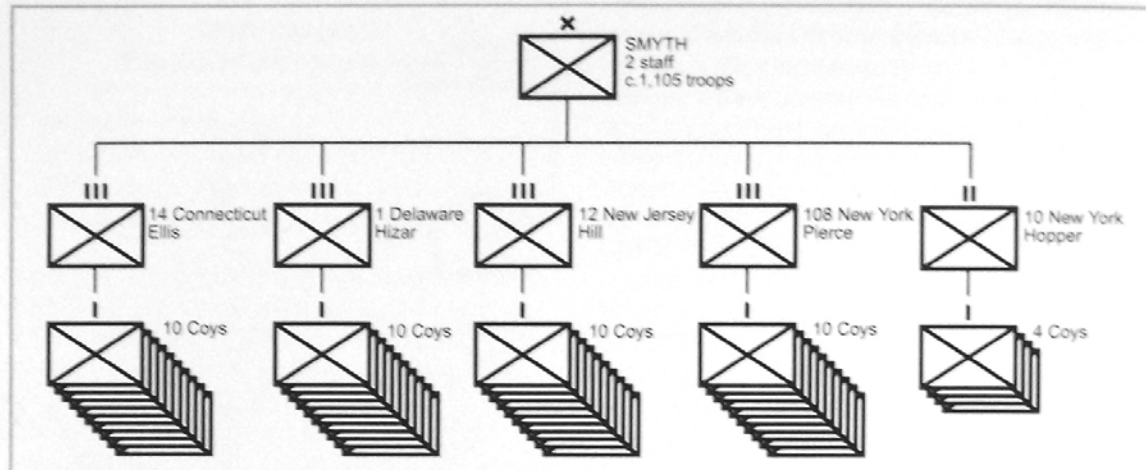
**14th Regiment Connecticut Infantry Volunteers**

Major Ellis

Cos. A through K.

1st Regiment Delaware Volunteers

Captain Hizar

Cos. A through K.

12th New Jersey Volunteer Infantry Regiment

Major Hill

Cos. A through K.

108th Regiment New York State Volunteers

Lieutenant-Colonel Pierce

Cos. A through K.

10th Battalion New York State Volunteers

Major Hopper

Cos. A through D.

Name: Christopher Flynn**Rank:** Corporal**Unit:** Co. K, 14th Regiment Connecticut Infantry Volunteers**Date:** July 3 1863**Citation:** Capture of flag of 52nd Carolina Regiment (C.S.A.)**Name:** William B. Hincks**Rank:** Sergeant-Major**Unit:** 14th Regiment Connecticut Infantry Volunteers**Date:** July 3 1863

Citation: During the highwater mark of Pickett's charge on 3 July 1863 the colors of the 14th Tennessee Infantry (C.S.A.) were planted 50 yards in front of the center of Sgt. Maj. Hinck's regiment. There were no Confederates standing near it but several lying down around it. Upon a call for volunteers by Maj. Ellis, commanding, to capture this flag, this soldier and 2 others leaped the wall. One companion was instantly shot. Sgt. Maj. Hincks outran his remaining companion running straight and swift for the colors amid a storm of shot. Swinging his saber over the prostrate Confederates and uttering a terrific yell, he seized the flag and hastily returned to his lines. The 14th Tennessee carried 12 battle honors on its flag. The devotion to duty shown by Sgt. Maj. Hincks gave encouragement to many of his comrades at a crucial moment of the battle.

Name: John B. Mayberry**Rank:** Private**Unit:** Co. F, 1st Regiment Delaware Volunteers**Date:** July 3 1863**Citation:** Capture of flag.**Name:** Bernard McCarren**Rank:** Private**Unit:** Co. C, 1st Regiment Delaware Volunteers**Date:** July 3 1863**Citation:** Capture of flag.**Name:** William H. Raymond**Rank:** Corporal**Unit:** Co. A, 108th Regiment New York State Volunteers**Date:** July 3 1863

Citation: Voluntarily and under a severe fire brought a box of ammunition to his comrades on the skirmish line.

conducted another counter-attack with the 1st Delaware and four more companies of the 12th New Jersey.

These units briefly recaptured the barn, secured 10 more prisoners, but retired in the face of renewed Confederate pressure. Lieutenant-Colonel Harris of the 1st Delaware issued the order to retreat, for which General Hancock ordered him placed under arrest. The 1st Delaware lost 32 casualties on July 2. By 2100 hrs firing finally ceased. Dawn on July 3 would bring a renewal of the contest for the Bliss farm and end in its final destruction.

Congressional Medals of Honor**Name:** Elijah W. Bacon**Rank:** Private**Unit:** Co. F, 14th Regiment Connecticut Infantry Volunteers**Date:** July 3 1863

Citation: Capture of flag of 16th North Carolina Regiment (C.S.A.)

The 3rd Brigade deployed into battalion columns just south of Cemetery Hill at 0800 hrs on July 2. The 39th New York provided a skirmish screen. For the next four hours it conducted a brisk combat, losing 28 men killed and wounded. At about 1200 hrs, General Hays ordered the brigade to withdraw and change position farther south along Cemetery Ridge.

At 1600 hrs, Hays ordered it again to move, this time in response to the impending collapse of Sickles' III Corps. Colonel George Willard, who commanded

THIRD BRIGADE

Colonel Eliakim Sherrill
Lieutenant-Colonel James R. Bull

39th Regiment New York State Volunteers
 (Garibaldi Guards) (Total casualties: 95)

Major Hugo Hildebrandt

111th Regiment New York State Volunteers
 (Wayne & Cayuga Regiment) (Total casualties: 249)

Colonel Clinton Dugald MacDougall

Lieutenant-Colonel Isaac M. Lusk

Captain Aaron P. Seeley

125th Regiment New York State Volunteers
 (Total casualties: 139)

Lieutenant-Colonel Clinton Levin Crandell

126th Regiment New York State Volunteers

(Total casualties: 231)

Lieutenant-Colonel James R. Bull

Successor unknown

Congressional Medals of Honor

Name: Morris Brown, Jr.

Rank: Captain

Unit: Co. A, 126th Regiment New York State Volunteers

Date: July 3 1863

Citation: Capture of flag.

Name: George H. Dore

Rank: Sergeant

Unit: Co. D, 126th Regiment New York State Volunteers

Date: July 3 1863

Citation: The colors being struck down by a shell as the enemy were charging, this soldier rushed out and seized it, exposing himself to the fire of both sides.

Name: Jerry Wall

Rank: Private

Unit: Co. B, 126th Regiment New York State Volunteers

Date: July 3 1863

Citation: Capture of flag.

the brigade on July 2, formed the regiments in battle line and ordered them to charge two enemy batteries. The advancing Yankees unexpectedly encountered Confederates in the underbrush of Plum Run. The brigade pushed on, recaptured a Union battery, and continued under severe front and flank fire. Willard judged the position untenable and ordered a withdrawal. The line was just re-forming east of Plum Run when an artillery shot killed Willard.

Colonel Eliakim Sherrill of the 126th New York

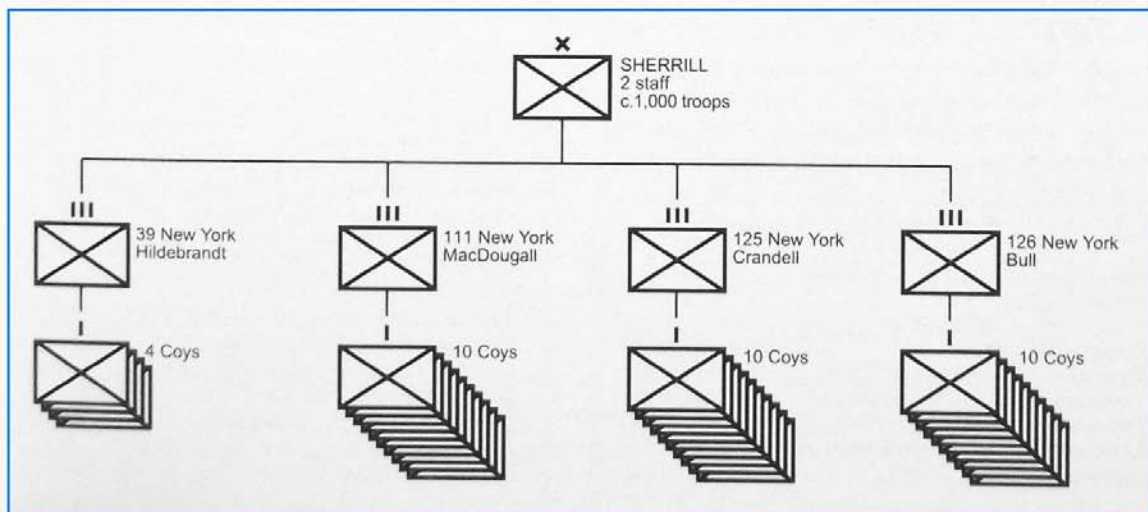

ascended to brigade command. He led the brigade back to its position on Cemetery Ridge. The official report on this day's action concluded, 'The coolness, courage, and determination displayed by officers and men throughout this trying occasion reflect great credit on them, and it is believed that the charge aided materially in maintaining our lines during the day.'

Many of the men had been captured at Harper's Ferry the previous year. When they charged on July 2, someone shouted, 'Remember Harper's Ferry!' Their gallant charge erased the stigma of their surrender in 1862 and gave them greater confidence for the coming rebel onslaught on July 3.

II Corps Artillery Brigade

On July 2, II Corps Artillery Brigade occupied positions along Cemetery Ridge. At around 1800 hrs, when rebel charges were lapping against the left-centre of this position, the brigade's two left-hand units, Battery B, 1st New York, and Battery B, 1st Rhode Island, withdrew to the crest of the ridge to conform with the retreat of the infantry. After gaining a more commanding position, they opened a rapid fire and inflicted heavy losses upon the attacking Confederates. The New York battery lost 1 killed and 8 wounded, while the Rhode Island battery lost 1 man killed, 7 wounded, and 2 missing. Indicative of the heavy fire the Rhode Island battery endured is its loss of 24 horses killed and 6 disabled. Losses compelled both batteries to dispatch two guns to the rear.

By 0800 hrs, July 3, the artillery was again in combat. Battery I, 1st U.S., alone had eight separate engagements before noon. Elsewhere, a sudden rebel bombardment exploded three limbers in Cushing's battery. It was a harbinger of things to come. They would shortly be in the thick of the fighting.

Congressional Medal of Honor

Name: Frederick Fuger

Rank: Sergeant

Unit: Battery A, 4th US Artillery

Date: July 3 1863

Citation: All of the officers of his battery having been killed or wounded and five of its guns disabled in Pickett's assault, he succeeded to the command and fought the remaining gun with most distinguished gallantry until the battery was ordered withdrawn.

39th Regiment New York State Volunteers

Major Hildebrandt

Cos. A through D.

111th Regiment New York State Volunteers

(Wayne & Cayuga Regiment)

Colonel MacDougall

Cos. A through K.

125th Regiment New York State Volunteers

Lieutenant-Colonel Crandell

Cos. A through K.

126th Regiment New York State Volunteers

Colonel Sherrill

Cos. A through K.

II CORPS ARTILLERY BRIGADE

Captain John Gardner Hazard

4 Staff and Field Officers

Battery B, 1st New York Light Artillery

(14th New York Battery Attached)

Captain James McKay Rorty/

Lieutenant Albert S. Sheldon/

Lieutenant Robert Eugene Rogers

(117 troops present for duty equipped)

(Total casualties: 26)

6 x 3-inch rifled guns

Battery A, 1st Rhode Island Artillery

Captain William Albert Arnold

(117 troops present for duty equipped)

(Total casualties: 32)

6 x 3-inch rifled guns

Battery B, 1st Rhode Island Artillery

Lieutenant William Smith Perrin

(129 troops present for duty equipped)

(Total casualties: 28)

6 x 12-pounder Napoleon guns

Battery I, 1st United States Artillery

Lieutenant George Augustus Woodruff/

Lieutenant Tully McCrea

(112 troops present for duty equipped)

(Total casualties: 25)

6 x 12-pounder Napoleon guns

Battery A, 4th United States Artillery

Lieutenant Alonzo Hereford Cushing/

Sergeant William Frederick Fuger

(126 troops present for duty equipped)

(Total casualties: 38)

6 x 3-inch rifled guns

THE ARMY OF THE POTOMAC II CORPS' BATTLES

Gibbon's and Hays' Divisions

Holding Cemetery Ridge – 1300–1500 hrs

The centre of the Army of the Potomac's line rested on the low, open crest of Cemetery Ridge. Hancock's II Corps held the ridge with Caldwell on the left, Gibbon in the centre, and Hays on the right. Doubleday's I Corps division occupied the angle between Gibbon and Caldwell. In front of Hays and Gibbon was II Corps' artillery. Hays' two brigades and Webb's Brigade of Gibbon's Division enjoyed the protection of stone walls. The remaining troops were in the open. The ridge commanded a view to the west stretching over a half-mile of open ground to Seminary Ridge. A heavy Union skirmish line stretched along the Emmitsburg Road.

By 0800 hrs sporadic artillery exchanges had begun. Responding to accurate rebel fire that exploded three of his caissons, Lieutenant Alonzo Cushing ordered his battery to return the rebel fire. The useless firing irritated the commander of II Corps Artillery Brigade. Captain John G. Hazard rode to Cushing's battery and sternly asked the lieutenant, 'Young man, are you aware that every round you fire costs the government two dollars and sixty-seven cents?' The battery dutifully fell silent.

Out on the picket line, an escalating firefight took place for possession of the Bliss barn. As had occurred the previous day, rebel sharpshooters firing from concealed positions in the barn made life miserable for the yankee soldiers manning the skirmish line along the Emmitsburg Pike. Their accurate fire also punished the gunners manning positions atop Cemetery Ridge. Accordingly, General Hays ordered

Colonel Smyth to silence these marksmen. Down the chain of command went the order. A captain in the 12th New Jersey, Richard Thompson, conducted four companies against the foe. Adding a detachment from the 1st Delaware that he encountered along the way, Thompson led about 200 men through the concealment of a chest-high wheat field towards the barn. When they entered the open they endured

The positions of Sherrill's, Smyth's, Webb's and Hall's Brigades on Cemetery Ridge at 0600 hrs on July 3.

From here, the Federal troops of II Corps watched the steady build-up of the Confederate gun line on Seminary Ridge opposite them.

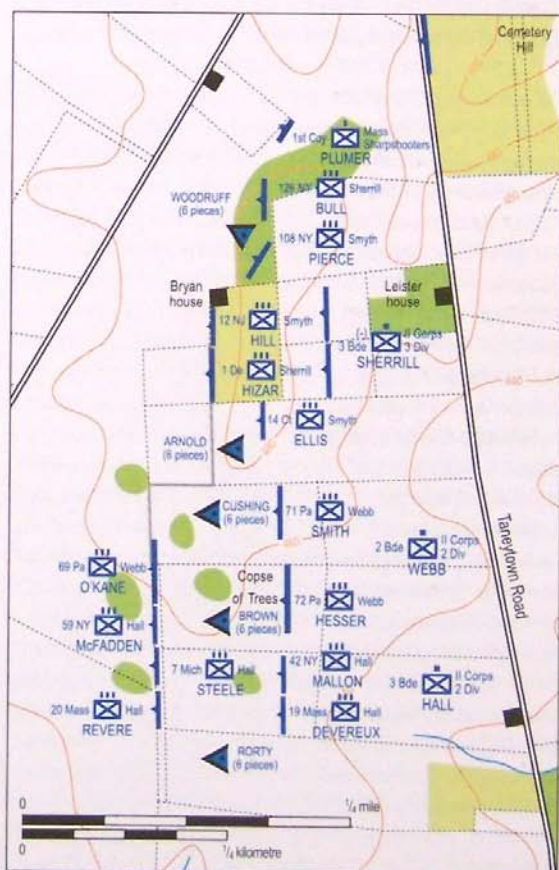

0400 hrs	0500	0600	0800	1000	1200	1300	1400	1500	1600	1700	1800
pages 75-76			35-4 & 91-95			17-19			90		

infantry and small-arms fire, but they did not stop. Thompson's charge secured the barn along with a handful of prisoners. It also stirred up a hornets' nest of opposition. The Confederates brought up a battery to shell the barn and launched a counter-attack that drove Thompson's detachment from the buildings. When the Union men returned to their line, someone asked, 'Why didn't you burn the barn?' General Hays apparently agreed. He ordered the 14th Connecticut to silence the enemy sharpshooters once and for all. This time four companies from the Connecticut regiment followed the same concealed route taken by Thompson but were pinned by heavy enemy fire. Hays sent four more companies into the fray. The additional strength allowed the yankees to regain the barn as well as the Bliss house.

The problem was that the house was too close to the main enemy battle line to be held, while the barn lacked any windows facing west. The bluecoats retired from the house. Hays did not know any of this. He ordered Smyth to 'have the men in the barn take that damned white house and hold it at all hazards'.

An escalating fight for control of the Bliss Farm began around 0700 hrs. This caused General Hays to reinforce his skirmish line. Combat persisted until about 1130 hrs. By the time it ended, elements of the 69th, 72nd and 106th Pennsylvania had reinforced the skirmish line. The fight for the Bliss Farm had the unforeseen benefit of causing some rebel batteries to fire-off scarce, long-range ammunition. After the battle for the farm ended, the troops lay beneath a broiling sun and awaited the coming Confederate bombardment.



Brigadier-General Henry J. Hunt's careful scheme to use his massed artillery collapsed when Hancock ordered the batteries to reply to the Confederate bombardment. (MOLLUS-Pennsylvania)

Shortly thereafter, Hays realised that his orders were unrealistic. He sent a new order for the men in the barn to fire the property and withdraw. This, of course, is what should have occurred the previous day. The Connecticut men set fire to the house and barn and retired. Nearby, Union skirmishers cheered at the sight of the blazing barn. It would no longer shelter enemy sharpshooters.

Between 1000 and 1100 hrs, the army's chief

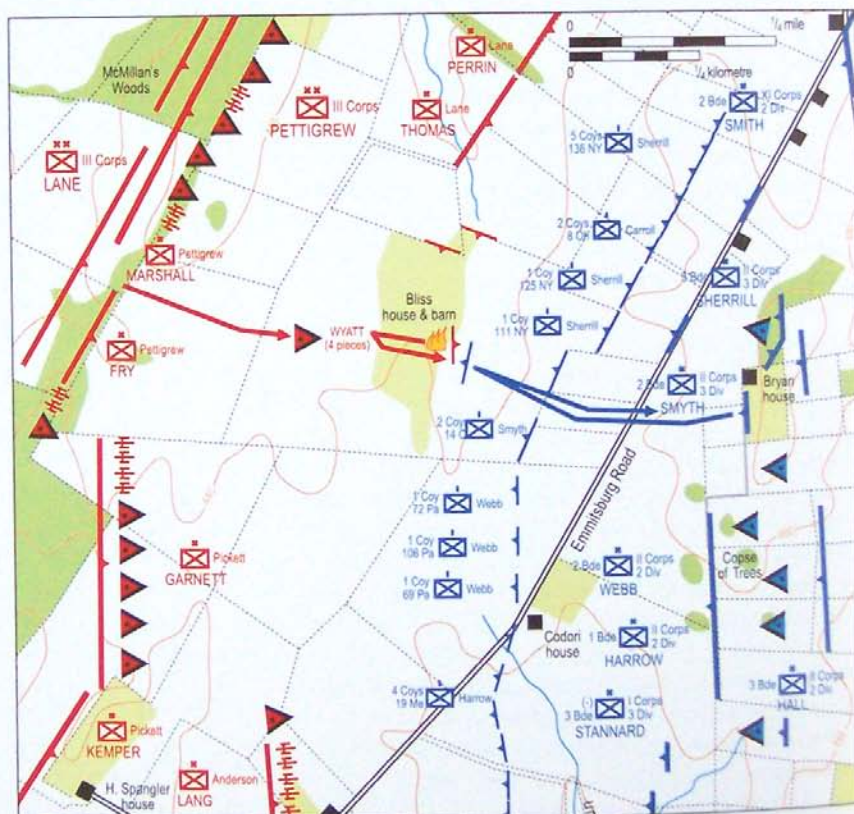

0400 hrs	0500	0600	0800	1000	1200	1300	1400	1500	1600	1700	1800
pages 75-76		35-4 & 91-95			17-19		90				

artillerist, Brigadier-General Hunt, returned to Cemetery Ridge from Culp's Hill: 'Here a magnificent display greeted my eyes. Our whole front for two miles was covered by batteries already in line or going into position. They stretched apparently in one unbroken mass from opposite the town to the Peach Orchard'. It was possible that this massive gun line was intended to fix Federal attention while the main attack came elsewhere. But Hunt judged it more likely that the rebel batteries intended a massive bombardment to be followed by an infantry assault. Hunt appreciated that his best defence depended upon having his batteries retain plenty of ammunition to repel the infantry.

Accordingly, he issued careful instructions to all of his batteries to refrain from returning the enemy's artillery fire for the first 15 or 20 minutes of the enemy's bombardment and thereafter to fire only at the most dangerous batteries and to fire slowly.

On Cemetery Hill, General Hunt told XI Corps artillerist, Major Thomas Osborn, that he anticipated a big enemy effort to drive the Union guns from the commanding height. He authorised Osborn to employ freely batteries from the reserve. Consequently, Osborn ordered up four more batteries, raising the number of guns he commanded to 34. Together with the other batteries, a total of 83 field pieces now occupied positions from Cemetery Hill to the Weikert farm on the south end of Cemetery Ridge.

As noon passed the air grew increasingly hot and oppressive. At about 1300 hrs, Confederate signal guns on Oak Hill fired. Then began the most celebrated artillery bombardment of the American Civil War. Amid cries of 'Down! Down!' the Union infantry hugged the ground. Survivors remembered the suffocating smoke from exploding projectiles and the sulphuric taste of burned powder. For everyone, it was the worst shelling they had ever experienced. Solid projectiles tore off heads, severed limbs and ripped apart bodies. The earth seemed to pitch and tremble. Spent projectiles showered soldiers with dirt and rock splinters. One of the limbers in Arnold's Battery A, Rhode Island Light Artillery, exploded and sent flames billowing into the sky. The opening fire killed 16 horses picketed to a rail at Meade's headquarters. Shirkers broke to the rear, some claiming they had to help wounded comrades, others running in blind terror.

Hancock rode into the worst of the fire to find his artillery commander. He commanded Hazard to open fire. Hazard explained Hunt's plan but Hancock would



As the Confederate charge went in, unbeknownst to the attackers there were ample Union reserves to plug any hole in the Yankee centre.

(Gettysburg Cyclorama)

have none of it. The corps commander believed that his men would waver unless his artillery showed them it was hitting back even as they suffered. In spite of Hancock's intercession, Hazard managed to wait his authorised 20 minutes before opening fire. This incident was the first of several understandable, but unfortunate, times Hancock meddled with Hunt's arrangements.

Because of Hancock, numerous Union batteries fired off most, or all, of their long-range ammunition. Hunt later estimated that fully one-third of the Union guns spent their ammunition in largely ineffective counter-battery fire before the enemy infantry advanced. They did, however, inflict about 200 losses among the Confederate infantry who were waiting to charge.

To huddle beneath the bombardment was a trial. A soldier in the 19th Maine related: 'It seemed as though, had a knitting needle stood on end, it would have been shot off a dozen times in so many minutes.' As it continued, it became clear that the most dangerous location was on Cemetery Ridge's reverse slope.

Most of the Confederate projectiles passed over the heads of the infantry and artillerymen on the front slope. Consequently, the reserve trains had to move away from the battle line to avoid the danger. Likewise, General Meade had to abandon his headquarters. Estimates of how long it lasted vary among the participants. Contrary to historical tradition, it probably lifted shortly before 1400 hrs. In part, a Federal subterfuge contributed to the bombardment's

0400 hrs	0500	0600	0800	1000	1200	1300	1400	1500	1600	1700	1800
pages 75-76						35-4 & 91-95		17-19		90	

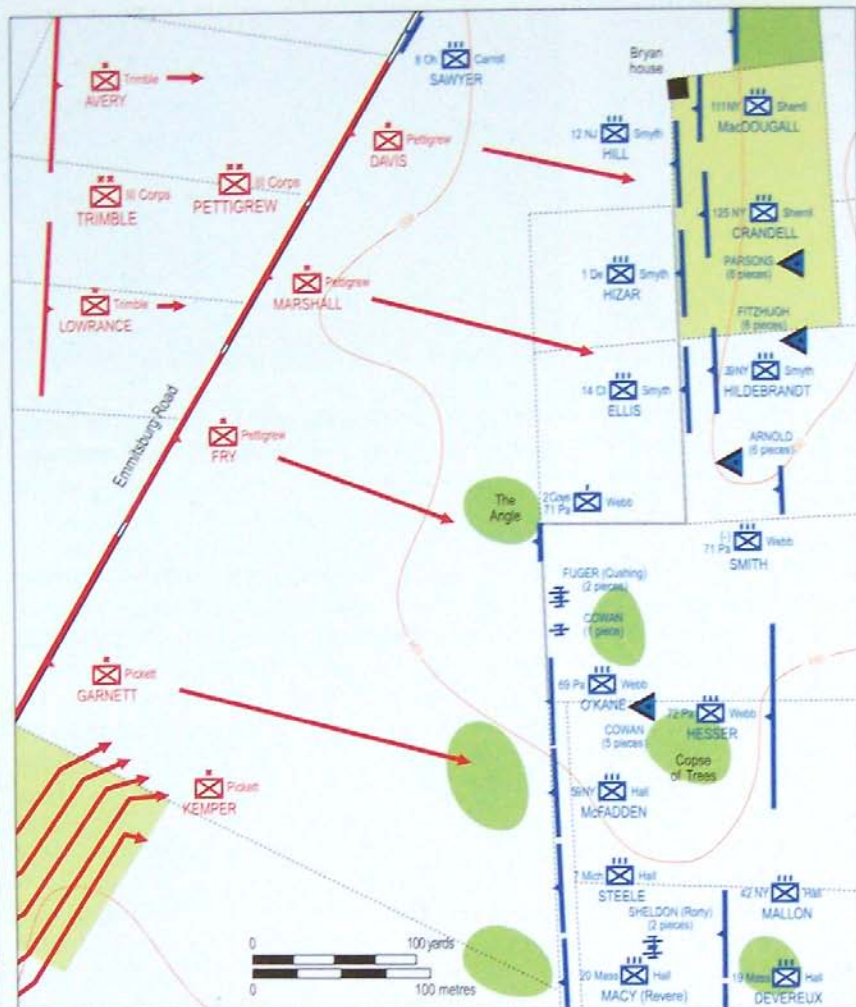

The advance of the Confederate infantry made a welcome respite from the fearsome artillery bombardment. In spite of the volume of rebel fire, the Union front-line infantry did not suffer greatly. Some Union batteries, particularly Cushing's, did suffer damage but fresh artillery was brought up from the reserve to bolster the line. The defenders atop Cemetery Ridge watched the Confederate infantry struggle to advance through a withering artillery fire, their frontage contracting all the time. About half of the rebel infantry in the front wave either failed to reach, or did not cross, the Emmitsburg Road.

end. Hunt rode among his batteries to order them to fall silent. He hoped both to save ammunition and to invite a Confederate attack. From a rebel perspective, this gradual reduction in Union return fire suggested that their own fire was knocking out enemy batteries.

In fact, besides interfering with the ammunition resupply system and driving Meade out of immediate command and control distance, the bombardment did not accomplish its objective of paving the way for the Confederate charge. As the Union infantry shook themselves into motion they glanced about and realised that they had suffered very little. The artillerymen, who had to remain standing to work their guns, were harder hit. Brown's and Rorty's batteries were driven from the field. Arnold retired because he

had no ammunition. Still, the survivors much welcomed the end of the shelling. A New Jersey infantryman spoke for the majority when he stood up to see the Confederates advancing through their gun line, 'Thank God! There comes the infantry!' Along the Union line, officers stiffened their men's resolve. A captain in the 8th Ohio said, 'Boys, they are going to make a charge. See that your guns are in order.' At the Angle, General Webb pointed to the Emmitsburg Road and said to the 69th Pennsylvania, 'Don't fire until they get over that fence.' Meanwhile, during the time that the rebel infantry formed, Hunt and his fellow artillery officers ordered up reserve batteries. By the time the charge began, there were 98 Federal guns along Cemetery Ridge to meet them. The Union artillery,

0400 hrs	0500	0600	0800	1000	1200	1300	1400	1500	1600	1700	1800
pages 75-76						35-4 & 91-95		17-19		90	

Confederate indifference to the security of their left flank astonished Federal officers in the 8th Ohio. While the rebel infantry concentrated on their advance, through canister and small-arms fire, against the stone wall, the 8th Ohio moved to enfilade the Confederate left. The 8th Ohio's tactical envelopment limited the breadth of the rebel front across the Emmitsburg Road.

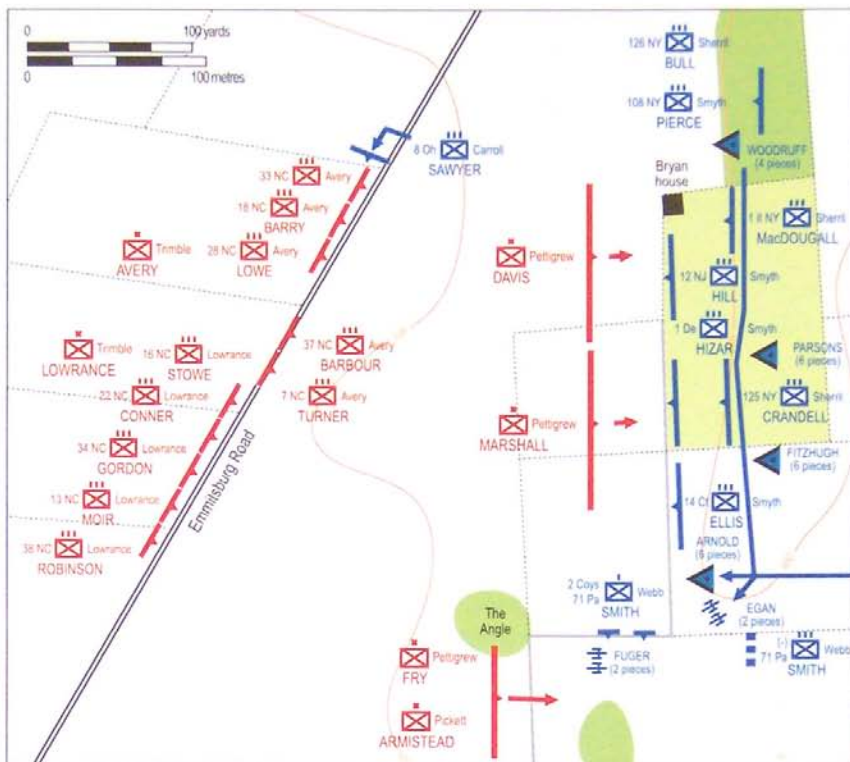

The Confederates penetrated the Union line in two places: the well-known assault at The Angle and a less celebrated breakthrough, across the Federal entrenchments on Hall's front, just south of the Copse of Trees. Elements of nine Federal regiments blunted the Confederate advance into the Copse of Trees, while 13th Vermont and 80th New York attacked the rebel right.

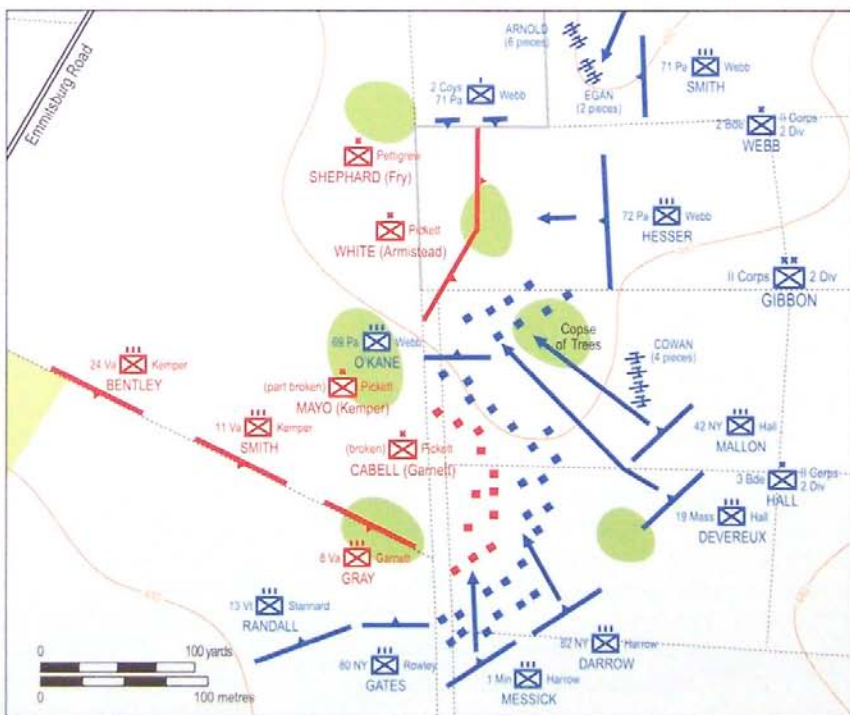

0400 hrs	0500	0600	0800	1000	1200	1300	1400	1500	1600	1700	1800
pages 75-76						35-4 & 91-95		17-19		90	

helped by the thick skirmish line, either killed, wounded, or drove back more than half the Confederate first wave before they could cross the Emmitsburg Road.

When the rebels did cross the road, they had lost tactical formation. First Lieutenant John Depuy of the 8th Ohio perceived that the enemy was paying no attention to their left flank. He shouted out, 'Will you follow me, boys?' and led the small regiment into a position from where they could enfilade the Confederates with deadly effect: 'The distinct graceful lines of the rebels underwent an instantaneous transformation. They were at once enveloped in a dense cloud of smoke and dust. Arms, heads, blankets, guns, and knapsacks were thrown and tossed into the clear air.' On the opposite flank, the inspired movement of Stannard's Vermonters forced the Confederates to converge towards the centre. Thus, the 7th Michigan found that after the enemy approached to within some 50 yards, the rebels moved to their own left flank, 'which obliged us to direct our fire to the right oblique, in order to keep them within range as long as possible'.

The survivors charged towards The Angle, where

they received fire from the Yankees deployed behind the stone walls. Soldiers in the 69th Pennsylvania had gathered as many as five muskets per man and loaded them each with 12 buckshot. At 20 yards' range they fired a first volley that caused fearful carnage. But the nearby 71st Pennsylvania was not so stout. When the charging rebels paused to fire a volley, one wing of the regiment broke in panic. A Union private recalled, 'I thought it was all up.' In another shaky unit, the 125th New York, a defender wrote about his fears that 'our line would give way as I noticed the uneasiness of some of the men'.

At Cushing's battery, Alonzo Cushing had received a mortal wound. Disregarding his injury he had ordered his three intact guns pushed forward to the low stone wall. From this position they fired point-blank canister against the enemy infantry. It did not stop them. Three rebels leaped the wall and killed two gunners before some nearby Pennsylvania infantry dropped them. Sergeant William Frederick Fuger, who had replaced Cushing, shouted for his men to 'run for your lives!' Then General Webb appeared to steady the gunners.

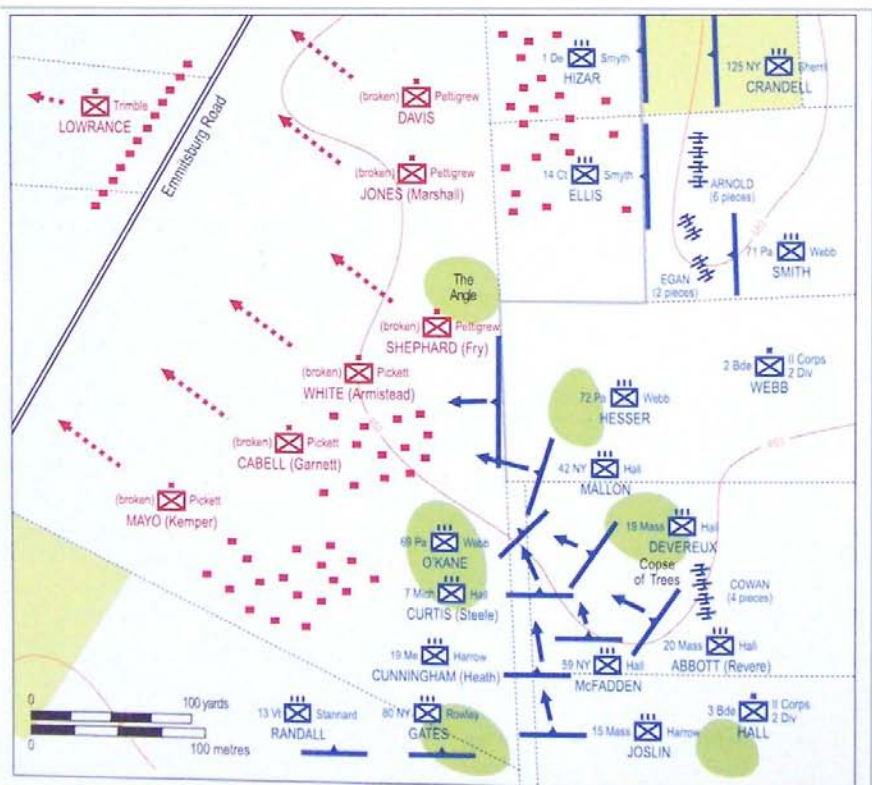

An intense fire-fight and hand-to-hand combat raged around the Cope of Trees. However, the defenders managed to bring up reinforcements, while the attackers had no reserves to exploit their narrow penetration. The Union counter-thrust sealed the breach and sent the survivors fleeing back to Seminary Ridge. The Confederate army was now vulnerable to an immediate counter-attack. Hancock, among others, saw the opportunity. However, since the rebel bombardment had driven Meade from his headquarters, he was late in perceiving this opportunity.

0400 hrs	0500	0600	0800	1000	1200	1300	1400	1500	1600	1700	1800
pages 75-76						35-4 & 91-95		17-19		90	



The Union victors collected about 1,500 Confederate prisoners amidst the debris of the failed rebel assault. (MARS)

A private yelled, 'My God, General! I can do nothing here alone!' Webb replied, 'You stay here and I will get you help.' Even as he finished speaking, a nearby caisson exploded. Perhaps inspired by Webb, Fuger yanked a cannon's lanyard and sent another round of canister into the surging enemy. Meanwhile, Webb gathered three companies of the 69th Pennsylvania and led them into the breach. Behind the battery, along the crest line northeast of the Copse of Trees, the 72nd Pennsylvania held firm. Its performance restricted the breadth of the Confederate breakthrough at The Angle.

The Confederates made a second penetration on Hall's front, just south of the Copse. A lieutenant in the 59th New York recalled, 'both the Regts on our right and left gave way, leaving our Regiment' alone to continue the fight. On either side of the two Confederate breakthroughs, the Union defenders slaughtered the enemy infantry. Some yelled out 'Fredericksburg! Fredericksburg!' to taunt the enemy with memories of their own slaughter when charging a stone wall. A frenzied soldier in the 126th New York shouted, 'Come on! Come on! Come to death!' The adjacent 12th New Jersey fired point-blank buck and ball loads, dropping four successive colour-bearers within the space of a few yards in the opposing Mississippi regiment. From sheltered positions on the northwestern side of Ziegler's Grove, a 21-man detachment of Andrews' Sharpshooters quickly shot down three mounted

officers including General Isaac Trimble.

Gibbon perceived the threat around the Copse of Trees and summoned help from Hall's Brigade. Hall understood his mission and directed the 20th Massachusetts to pull out of line and move towards the Copse and attack the rebel flank. Other nearby units joined in the counter-attack. Hancock rode up to Colonel Devereux of the 19th Massachusetts and motioned toward the enemy colours flying inside The Angle, 'Get in God Damn quick!' Hancock rounded up additional regiments, including the 42nd New York, and ordered them in as well. Inside The Angle, a wild but brief close-range encounter ensued. The Yankees held all the advantages; position, numbers, morale, momentum. After about five minutes, the rebels broke.

When Meade arrived on Cemetery Ridge he saw an enemy mass and thought the Confederates had made a breakthrough. In fact, it was a mass of prisoners. He asked, 'How is it going here?' When told that the attack had been repulsed, Meade exclaimed, 'What! Is the assault already repulsed?' Hearing the news affirmed, he said, 'Thank God,' and sighed. Afterwards, it could be seen that the Confederate assault was doomed from the start.

II Corps' Casualties at Gettysburg
July 3 1863

Infantry killed or wounded 858
 Infantry missing/captured 105
 Artillery killed or wounded 129
 Artillery missing/captured 1

0400 hrs	0500	0600	0800	1000	1200	1300	1400	1500	1600	1700	1800
pages 75-76						35-4 & 91-95		17-19		90	

THE ARMY OF THE POTOMAC

III CORPS

On the afternoon of July 2, Major-General Daniel Sickles gazed from his corps' position on the low ground of Cemetery Ridge towards the higher ground along the Emmitsburg Road. Having learned at Chancellorsville about the importance of securing the high ground, Sickles resolved to interpret his orders very loosely and move his corps about a mile to the west to occupy the area of the Peach Orchard. From a Federal standpoint, this proved to be one of the battle's most controversial decisions.

III Corps' new V-shaped position was well in advance of the main Union battle line. The troops defending the Peach Orchard formed a salient and could be attacked from three directions and were vulnerable to artillery fire. Longstreet's subsequent assault shattered III Corps. Almost all of the 4,211 casualties the corps suffered occurred on July 2. Except for some artillery batteries, the corps did not engage on July 3.

The July 2 combat also knocked Sickles out of action when a cannonball shattered his leg. Showing great courage, he deliberately puffed on a cigar so that his men would know that he was alive while stretcher bearers carried him to the rear. Hours later, surgeons amputated his leg just above the knee. Corps command passed to Major-General David Birney.

Sickles' gallant departure from the field provided him with a useful hero's mantle that obscured his martial incompetence. After the war, some argued

III CORPS HEADQUARTERS

ESCORT

Co. A, 6th New York Volunteer Cavalry Regiment

Major William Elliott Beardsley

51 troops present for duty equipped



Major-General David Bell Birney ascended to corps command just as his division was being routed and presided over a battlefield débâcle. His military career ended with his life, when he died of typhoid in 1864.

(U.S. National Archives)

that, by advancing to the Emmitsburg Road, III Corps had absorbed the rebel attack well in advance of the Round Tops and thus purchased time for other units to occupy the vital heights. Then and thereafter, most historians concurred that Sickles' decision to fight well forward was a mistake.

The corps participated in the Mine Run and Bristow Station campaigns in the autumn. Thereafter, when Meade made plans to consolidate his corps, he earmarked III Corps as one of the formations which was to be disbanded.

III CORPS

Major-General David Bell Birney

9 Staff and Field Officers

First Division

Brigadier-General John Henry Hobart Ward

Second Division

Brigadier-General Andrew Atkinson Humphreys

III Corps Artillery

Captain George E. Randolph

III Corps Casualties at Gettysburg

July 3 1863

Infantry killed or wounded 30

Infantry missing/captured 10

Artillery killed or wounded 10

Artillery missing/captured 0

III CORPS — GETTYSBURG — July 3

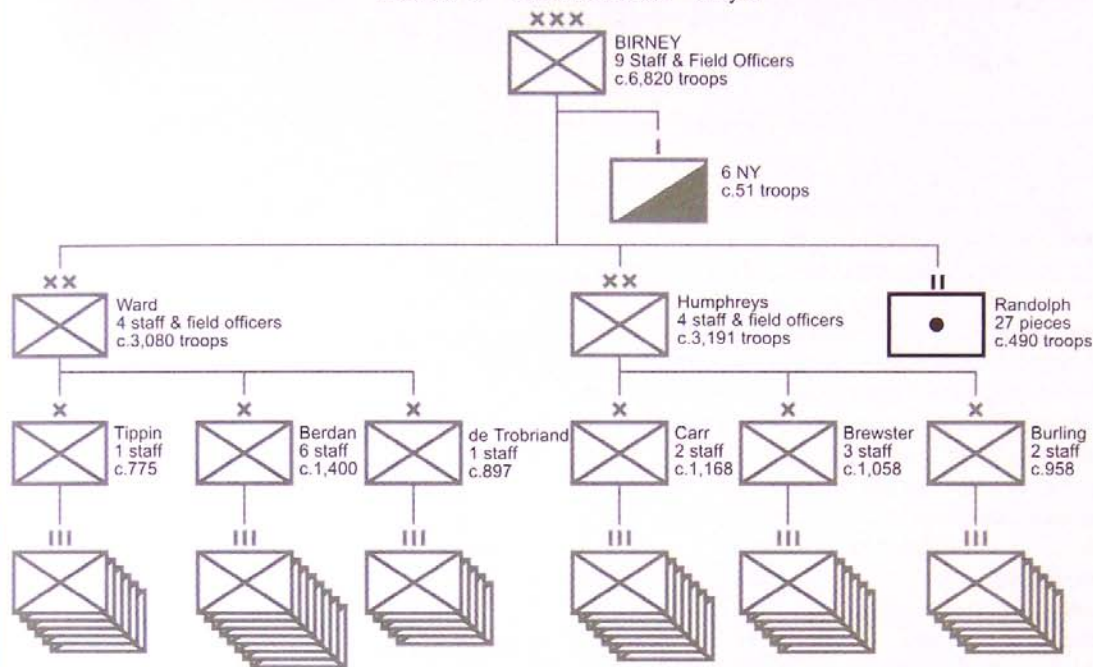

Senior officers judged III Corps unfit for combat on July 3. Consequently, it was assigned as a reserve. The exact order in which each of the division's brigades were deployed is unknown but they were in column by brigade. Its presence provided Meade with extra assurance that, if Lee repeated his attempt to attack the Union centre-left, there would be enough defenders to repulse him. Towards the end of Pickett's and Pettigrew's charge, III Corps moved north to support II Corps but were not engaged.

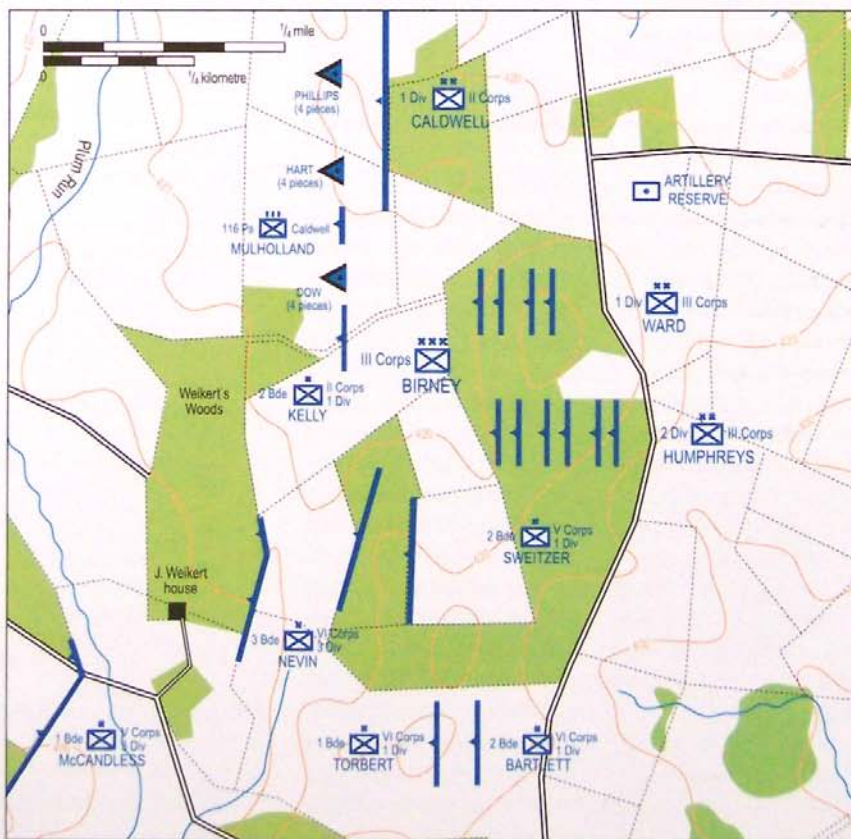

III Corps – 1st Division



On July 2, III Corps' 1st Division advanced to occupy elevated ground around the Peach Orchard. General Sickles incorrectly believed that it dominated Cemetery Ridge. The division's line extended east and south from the Peach Orchard across Stony Hill to the Devil's Den. It was an overly extensive front and vulnerable to artillery fire.

About 1630 hrs, Confederates belonging to Hood's Division assaulted the division's left. As would be the case throughout the struggle, most defenders fought hard, but they also fought in relative tactical isolation from one another. Indeed, individual regiments

On July 2, Brigadier General John Henry Hobart Ward's brigade bore the brunt of a rebel attack. His military career ended in a shocking episode of drunkenness and cowardice in the Wilderness.

(U.S. National Archives)

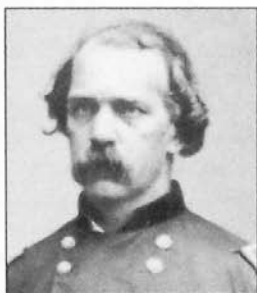

engaged without tactical co-ordination. An hour into the assault, a new threat emerged when 3,000 more rebel infantry charged directly against the Peach Orchard. This assault overran the salient and rolled up the defensive line along the Emmitsburg Road. At about 1800 hrs, when Sickles retired from the field, Major-General Birney ascended to corps command and the division's senior brigadier, John Ward, replaced Birney. Remnants of the division continued to contest the Confederate advance but the remainder routed off the field. Gazing at his defeated remnants, Birney purportedly said at this time, 'I wish I were already dead.'

During Meade's council of war, a defeated Birney said that his corps was 'used up'. The action around the Wheat Field and the Devil's Den cost the division about 1,050 men. The fight in the Peach Orchard cost about another 1,200 troops. This was a terrible loss rate amounting to nearly one man in two. During July 3 the division remained in reserve, where it endured heavy artillery fire. Thereafter, it moved up to support Newton's line but its help was not needed.

FIRST DIVISION

Brigadier-General John Henry Hobart Ward

(division deployed but not engaged on July 3)

FIRST BRIGADE

Colonel Andrew Hart Tippin

57th Regiment Pennsylvania Volunteer Infantry
(Total casualties: 115)

Captain Alanson H. Nelson

63rd Regiment Pennsylvania Volunteer Infantry
(Total casualties: 34)

Major John Anderson Danks

68th Regiment Pennsylvania Volunteer Infantry
(Total casualties: 152)

Captain Milton S. Davis

105th Regiment Pennsylvania Volunteer Infantry
(Total casualties: 132)

Colonel Calvin Augustus Craig

114th Regiment Pennsylvania Volunteer Infantry
(Collis' Zouaves de Afrique) (Total casualties: 155)

Captain Edward Roscoe Bowen

141st Regiment Pennsylvania Volunteer Infantry
(Total casualties: 149)

Colonel Henry John Madill

SECOND BRIGADE

Colonel Hiram Berdan

20th Regiment Indiana Volunteer Infantry
(Total casualties: 156)

Lieutenant-Colonel William C.L. Taylor
3rd Regiment Maine Volunteer Infantry
(Total casualties: 122)

Colonel Moses B. Lakeman

4th Regiment Maine Volunteer Infantry
(Total casualties: 144)

Captain Edwin Libby

86th Regiment New York State Volunteers
(Steuben Rangers) (Total casualties: 66)

Lieutenant-Colonel Benjamin L. Higgins

124th Regiment New York State Volunteers
(American Guard) (Total casualties: 90)

Lieutenant-Colonel Francis M. Cummins

99th Regiment Pennsylvania Volunteer Infantry
(Total casualties: 110)

Major John William Moore

1st Regiment of United States Sharpshooters
(Total casualties: 49)

Lieutenant-Colonel Casper Trepp

2nd Regiment of United States Sharpshooters
(Total casualties: 43)

Major Homer Richard Stoughton

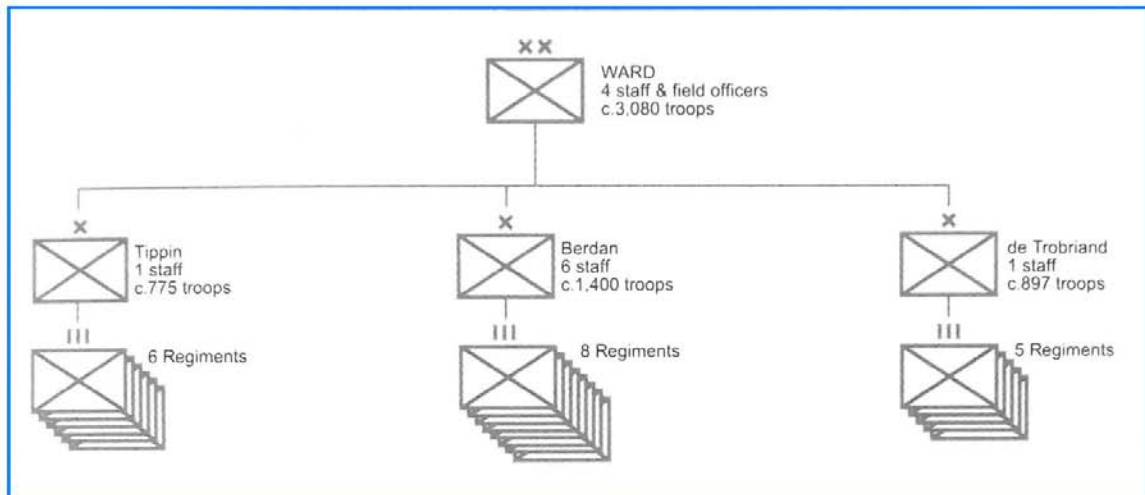

THIRD BRIGADE

Colonel Philippe Régis Denis de Keredern de Trobriand

17th Regiment Maine Volunteer Infantry

(Total casualties: 133)

Colonel Charles Benjamin Merrill

3rd Regiment Michigan Volunteer Infantry

(Total casualties: 45)

Lieutenant-Colonel Edwin S. Pierce

5th Regiment Michigan Volunteer Infantry

(Total casualties: 109)

Lieutenant-Colonel John Pulford

40th Regiment New York State Volunteers

(Constitution Guard) (Total casualties: 150)

Colonel Thomas Washington Egan

110th Regiment Pennsylvania Volunteer Infantry

(Total casualties: 53)

Major Isaac Rogers

Congressional Medals of Honor

Name: Oliver P. Rood

Rank: Private

Unit: Co. B, 20th Indiana Volunteer Infantry

Date: July 3 1863

Citation: Capture of flag of 21st North Carolina Infantry (C.S.A.).

Name: Harvey M. Munsell

Rank: Sergeant

Unit: Co. A, 99th Regiment Pennsylvania Volunteer Infantry

Date: July 3 1863

Citation: Gallant and courageous conduct as color bearer.

(This noncommissioned officer carried the colors of his regiment through 13 engagements.)

III Corps – 2nd Division



When Sickles ordered the corps to advance, the 2nd Division occupied an exposed position along the Emmitsburg Road facing west towards a line of woods that sheltered the rebel assault brigades. The division's left was tenuously tied to the 1st Division; its right was dangling in air, more than half a mile in front of Hancock's II Corps on Cemetery Ridge.

Humphreys exerted himself heroically to help his men hold this ground. He was seen 'at the most exposed positions in the extreme front, giving personal attention' to the division's manoeuvres. When a shell fragment struck his already wounded horse, the

A skilled and heroic performance on July 2 earned Brigadier-General Andrew Atkinson Humphreys quick promotion. The Assistant Secretary of War called him 'the great soldier of the Army of the Potomac'. His division was not committed on July 3. (USAMHI, Carlisle)

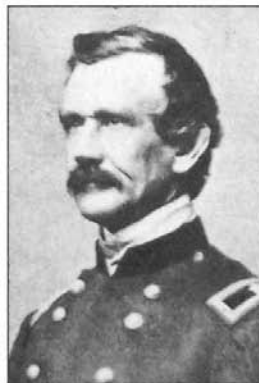

SECOND DIVISION**Brigadier-General Andrew Atkinson Humphreys**

(division deployed but not engaged on July 3)

FIRST BRIGADE**Brigadier-General Joseph Bradford Carr**

1st Regiment Massachusetts Volunteer Infantry

(Total casualties: 120)

Lieutenant-Colonel Clark B. Baldwin

11th Regiment Massachusetts Volunteer Infantry

(Total casualties: 129)

Lieutenant-Colonel Porter D. Tripp

16th Regiment Massachusetts Volunteer Infantry

(Total casualties: 81)

Captain Matthew Donovan

12th Regiment New Hampshire Volunteers

(Total casualties: 92)

Captain John F. Langley

11th Regiment New Jersey Volunteer Infantry Regiment

(Total casualties: 153)

Captain Samuel T. Sleeper/

Lieutenant-Colonel John Schoonover

26th Regiment Pennsylvania Volunteer Infantry

(Total casualties: 213)

Major Robert Lewis Bodine

84th Regiment Pennsylvania Volunteer Infantry

(Guarding trains – not engaged at Gettysburg)

Lieutenant-Colonel Milton Opp

SECOND BRIGADE**Colonel William R. Brewster**

70th Regiment New York State Volunteers

(1st Regiment, Excelsior Brigade) (Total casualties: 117)

Colonel John Egbert Farnum

71st Regiment New York State Volunteers

(2nd Regiment, Excelsior Brigade) (Total casualties: 91)

Colonel Henry Langdon Potter

72nd Regiment New York State Volunteers

(3rd Regiment, Excelsior Brigade) (Total casualties: 114)

Lieutenant-Colonel John Leonard

73rd Regiment New York State Volunteers

(4th Regiment, Excelsior Brigade) (Total casualties: 162)

Major Michael William Burns

74th Regiment New York State Volunteers

(5th Regiment, Excelsior Brigade) (Total casualties: 89)

Lieutenant-Colonel Thomas Holt

120th Regiment New York State Volunteers

(Washington Guard) (Total casualties: 203)

Major John R. Tappen

THIRD BRIGADE**Colonel George Childs Burling**

2nd Regiment New Hampshire Volunteers

(Total casualties: 193)

Colonel Edward Lyon Bailey

5th Regiment New Jersey Volunteer Infantry

(Total casualties: 94)

Captain Thomas C. Godfrey/

Captain Henry H. Wollsey

6th Regiment New Jersey Volunteer Infantry

(Total casualties: 41)

Lieutenant-Colonel Stephen Rose Gilkyson

7th Regiment New Jersey Volunteer Infantry

(Total casualties: 114)

Major Frederick Cooper

8th Regiment New Jersey Volunteer Infantry

(Total casualties: 47)

Captain John G. Langston

115th Regiment Pennsylvania Volunteer Infantry

(Total casualties: 24)

Major John Peter Dunne

Jersey lost 114 men at the Peach Orchard alone.

After breaking the salient, the Confederates rolled up the division's left flank. Here the division suffered fearful losses. During the fight between the Emmitsburg Road and Cemetery Ridge, the 1st Brigade lost an estimated 788 men and the 2nd Excelsior Brigade an estimated 776. The 5th New Jersey also fought on this front and lost an estimated 94 casualties.

In Humphreys' words, 'The fortune of war rarely places troops under more trying circumstances than those in which my division found itself on this day.' The division sustained its fine reputation but paid a terrible price. Forty percent of the division became casualties on July 2. When General Hancock saw the survivors it seemed to him that there was nothing left except a mass of regimental flags still defiantly waving. Humphreys later recalled that the day's stern fighting was worse than the division's futile effort to storm the stone wall at Fredericksburg.

The division remained on Cemetery Ridge until sunrise the next morning, when it moved rearward to resupply depleted cartridge boxes. For the rest of the day, it remained in reserve on the rear slope of Cemetery Ridge, in a position supporting units of V Corps. When the Confederate charge against the centre occurred, the division moved to support the left of II Corps. Formed in mass by battalion, it suffered some losses from rebel artillery fire.

Humphreys received promotion and became Meade's new chief of staff. Upon Hancock's retirement from the Army of the Potomac, due to his Gettysburg wound, Humphreys again returned to field command as leader of II Corps.

animal reared and tossed him violently to the ground. He remounted and continued prominently to display himself to his battered soldiers.

However, overwhelming Confederate waves and the fact that superior officers removed the division's support at critical times, amplified his problems. This combination caused the division to collapse. Indicative of the heavy casualties caused by the impossible effort to defend the salient was the 2nd New Hampshire's loss of 193 out of 330 men engaged. The 7th New

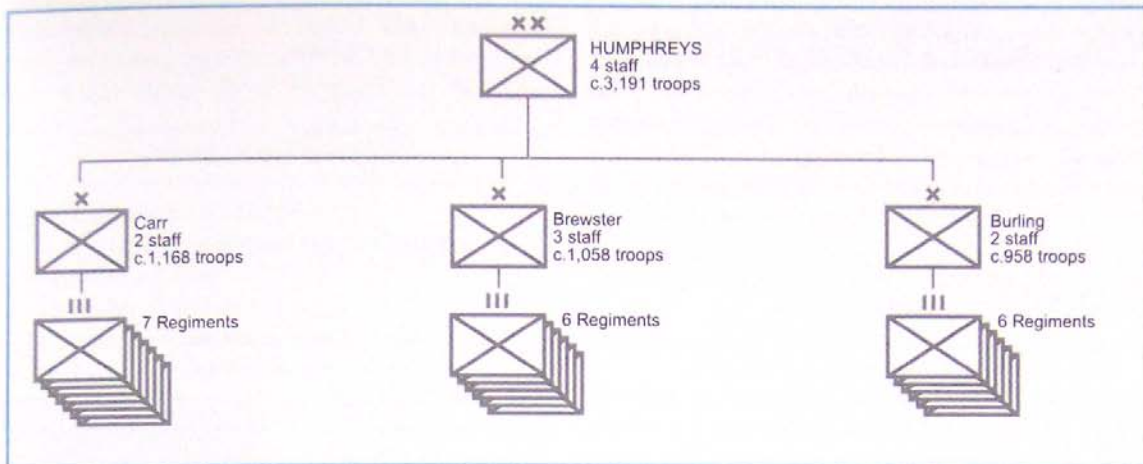

III Corps Artillery Brigade

The five batteries comprising III Corps Artillery Brigade participated in the July 2 débâcle.

Cumulatively, they lost over 100 men including 8 enlisted men killed, 3 officers and 78 enlisted men wounded, and 17 enlisted men missing. About 108 horses were killed or disabled. The 4th New York Battery was in a difficult tactical situation. Its losses included three 10-pounder Parrotts abandoned. The battery captain plaintively reported, 'I trust no blame will be attached to me for the loss of my guns. I did that which in my judgment I thought best.'

The five batteries of III Corps' Artillery Brigade suffered heavily on July 2 and, with the exception of Battery K, 4th U.S., did not engage on July 3. (Author's collection)



On July 3, Battery K, 4th U.S., participated in an early morning skirmish with rebel artillery and sharpshooters. After firing off all of its ammunition, it retired to a reserve position and did not engage again.

III CORPS ARTILLERY BRIGADE Captain George E. Randolph

Battery B, 2nd New Jersey Light Artillery

Captain Adoniram Judson Clark
(131 troops present for duty equipped)
(Total casualties: 20)

6 x 10-pounder Parrott rifled guns

Battery D, 1st New York Light Artillery

Captain George Bigelow Winslow
(116 troops present for duty equipped)
(Total casualties: 18)

6 x 12-pounder Napoleon guns

4th Battery, New York Light Artillery

Captain James Edward Smith
(126 troops present for duty equipped)
(Total casualties: 13)

3 x 10-pounder Parrott rifled guns

Battery E, 1st Rhode Island Light Artillery

Lieutenant John Knight Buckley
(108 troops present for duty equipped)
(Total casualties: 30)

6 x 12-pounder Napoleon guns

Battery K, 4th United States Artillery

Lieutenant Francis Webb Seeley
(113 troops present for duty equipped)
(Total casualties: 25)

6 x 12-pounder Napoleon guns

THE ARMY OF THE POTOMAC

V CORPS

V Corps began July 2 massed in preparation for an attack against the Confederate left. When Meade discarded this plan, the corps moved to the Union left to support Sickles' III Corps. While the Corps was en route, Longstreet began his assault. Consequently, the corps entered battle piecemeal.

V CORPS

Major-General George Sykes

7 Staff and Field Officers

First Division

Major-General James Barnes

Second Division

Brigadier-General Romeyn Beck Ayres

Third Division

Brigadier-General Samuel Wylie Crawford

V Corps Artillery

Captain Augustus P. Martin

Major-General George Sykes never again performed as skilfully as he did at Gettysburg on July 2. The following day his corps held the left flank of the Federal army on the Round Tops. He ended his postwar military career as colonel of a frontier regiment. (MARS)



Its most critical contribution came when Meade ordered Little Round Top held 'at all costs'. Strong Vincent's Brigade tenaciously defended the heights and achieved immortal glory.

Corps commander Major-General George Sykes sent reinforcements to Vincent while also sending

V Corps remained in the positions it held at the end of July 2 on the Round Tops and east of the Wheatfield. It faced the Confederate troops of Law's Division, but Sykes' men were not tested on July 3. The corps had done excellent work the previous day and was content to allow other units to bear the burden of combat on the final day of the battle.

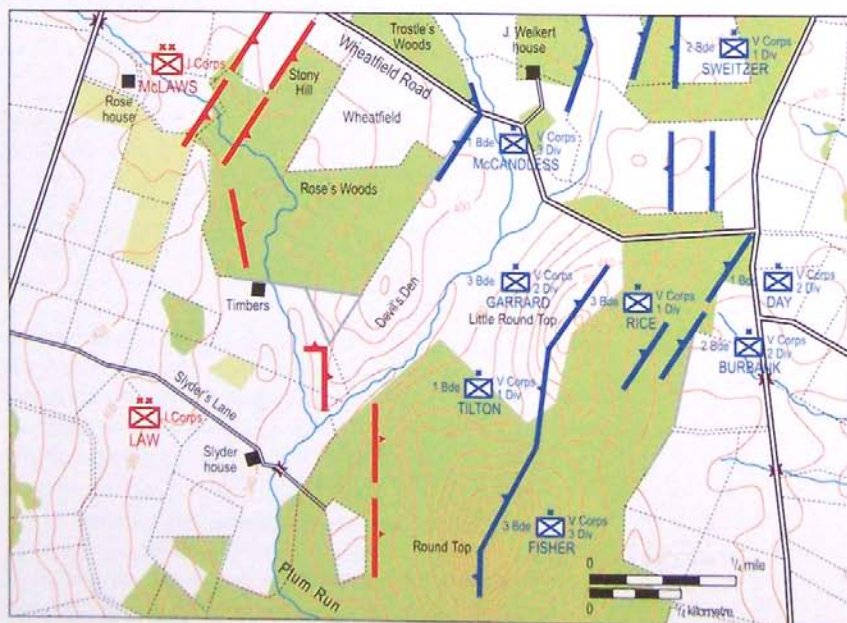

other units to plug gaps in Sickles' line. The corps fought in the area from Stony Hill to Little Round Top. Here it lost almost all of its casualties. The final

total was 28 officers and 337 enlisted men killed; 129 officers and 1,482 enlisted men wounded; 1 officer and 210 enlisted men missing. This total of 2,187 represented nearly 20 percent of its strength. Referring to his men's defence of Little Round Top, General Sykes proudly reported, 'Night closed the fight. The key of the battle-field was in our possession intact.'

V CORPS HEADQUARTERS

PROVOST GUARD & ESCORT

Cos. D & E, 12th Regiment New York State Volunteers
(Independence Guards)

Captain Henry Wines Rider
(109 troops present for duty equipped)

Cos. D & H, 17th Regiment Pennsylvania Cavalry
(162nd Volunteers)

Captain William Thompson
(78 troops present for duty equipped)

V Corps' Casualties at Gettysburg July 3 1863

Infantry killed or wounded 0
Infantry missing/captured 0
Artillery killed or wounded 3
Artillery missing/captured 0

V CORPS — GETTYSBURG — July 3

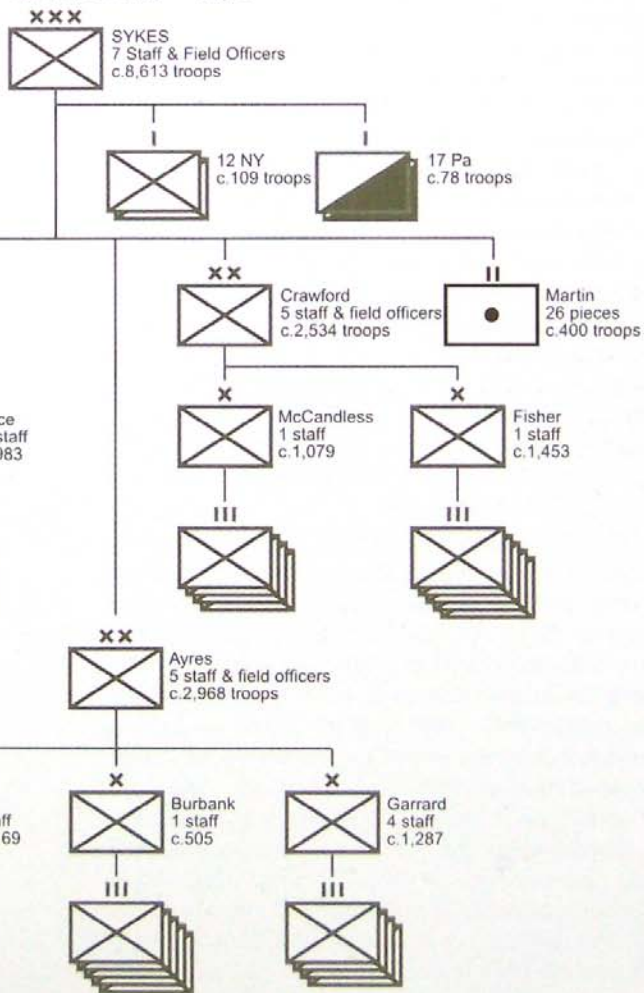

V Corps – 1st Division



When the inexperienced Brigadier-General James Barnes led his division into battle on July 2 he faced a confusing, but critical, situation. According to a soldier in Vincent's Brigade, Barnes contributed nothing useful to the ensuing fight.

Strong Vincent led his brigade to Little Round Top where it fought hard to retain this key to the entire Union position. This combat produced one of the most memorable encounters of the entire battle – the fight between Chamberlain's 20th Maine and Law's Alabamians. Vincent himself fell mortally wounded at the climax of the fighting. The 1st Brigade's four regiments lost 340 men killed and wounded with only 13 missing during the struggle for Little Round Top. This represented a loss rate of more than one in four.

Brigadier-General James Barnes was wounded on July 2. His division did not see action on July 3. Barnes never returned to combat and spent the remainder of the war on administrative duty in Washington. He died in 1869.

(USAMHI, Carlisle)



The division's other two brigades marched to support Birney's Division. During the ensuing action, Barnes became concerned about a perceived gap between Stony Hill and the Peach Orchard. On his own initiative, he ordered a 300-yard withdrawal. This left Birney's embattled soldiers dangerously exposed and contributed to their collapse. During the swirling combat around the Wheatfield, Tilton's weak brigade escaped relatively lightly. It lost 114 men killed and wounded and 11 missing, about one man in five.

Sweitzer's Brigade, minus the 9th Massachusetts, also participated in this fighting. The three regiments delivered a spirited counter-attack and lost 299 men killed and wounded and 121 missing, nearly 30 percent of the men engaged. Barnes himself received a disabling wound near the end of the day's fighting, ceding command to General Charles Griffin

FIRST DIVISION

Brigadier-General James Barnes
(division deployed but not engaged on July 3)

FIRST BRIGADE

Colonel William Stowell Tilton

18th Regiment Massachusetts Volunteer Infantry
(Total casualties: 27)

Colonel Joseph Hayes

22nd Regiment Massachusetts Volunteer Infantry
(Total casualties: 31)

Lieutenant-Colonel Thomas Sherwin, Jr.

1st Regiment Michigan Volunteer Infantry
(Total casualties: 42)

Lieutenant-Colonel William A. Throop

118th Regiment Pennsylvania Volunteer Infantry
(Total casualties: 25)

Lieutenant-Colonel James Gwyn

SECOND BRIGADE

Colonel Jacob Bowman Sweitzer

9th Regiment Massachusetts Volunteer Infantry
(Regiment on right flank picket duty)

Colonel Patrick Robert Guiney

32nd Regiment Massachusetts Volunteer Infantry
(Total casualties: 80)

Colonel George Lincoln Prescott

4th Regiment Michigan Volunteer Infantry
(Total casualties: 165)

Lieutenant-Colonel George W. Lumbard

62nd Regiment Pennsylvania Volunteer Infantry
(Total casualties: 175)

Lieutenant-Colonel James C. Hull

THIRD BRIGADE

Colonel James Clay Rice

20th Regiment Maine Volunteer Infantry
(Total casualties: 125)

Colonel Joshua Lawrence Chamberlain

16th Regiment Michigan Volunteer Infantry
(Total casualties: 60)

Colonel Norval E. Welch

44th Regiment New York State Volunteers
(Ellsworth Avengers) (Total casualties: 111)

Lieutenant-Colonel Freeman Conner

83rd Regiment Pennsylvania Volunteer Infantry
(Total casualties: 55)

Captain Orpheus S. Woodward

after the battle, and never recovered sufficiently to resume field command. The 1st Division remained on the Round Tops on July 3 and did not engage.

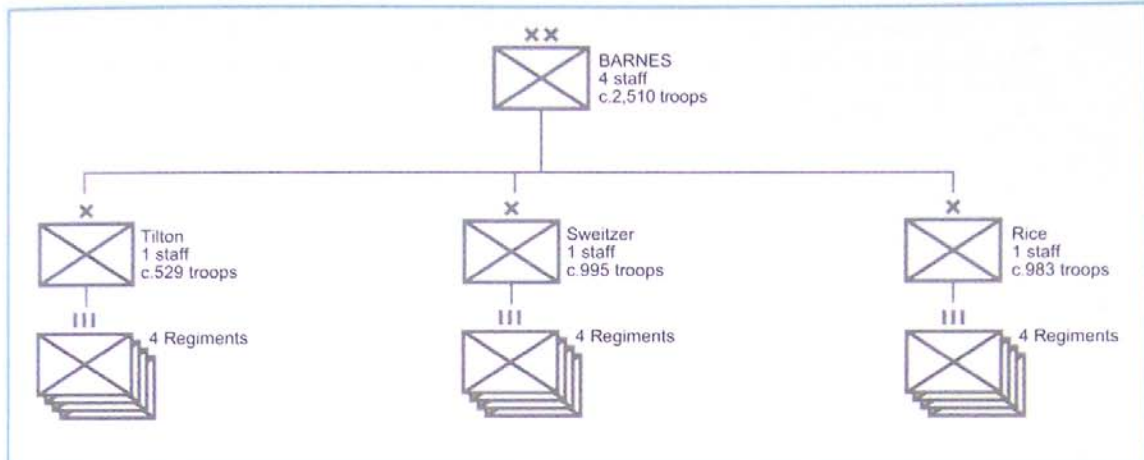

V Corps – 2nd Division

The Regular Division



As the 2nd Division neared the Federal left on 2 July, Major-General Sykes sent the leading brigade, commanded by Brigadier-General

During July 3, Brigadier-General Romeyn Beck Ayres' Division held Little Round Top, but did not engage. After the war, he remained on active duty, and served with the artillery until his death in 1888.

(USAMHI, Carlisle)



Stephen Weed, to support Vincent's Brigade. Thus, Brigadier-General Romeyn Ayres, like most Union divisional commanders on July 2, had to fight with his brigades out of mutual support. During the 3rd Brigade's ensuing defence of Little Round Top, Weed himself fell to a rebel sharpshooter. When an aide suggested that he may not be seriously hurt, Weed replied, 'I'm as dead a man as Julius Caesar.' A few hours later he died. A total of 191 men were killed and wounded and 18 were missing. Overall, the brigade was spared the heaviest fighting, which occurred to its left when the rebels charged Vincent's Brigade. Over 14 percent of Weed's men became casualties on July 2. The brigade maintained its position on July 3 but was not engaged.

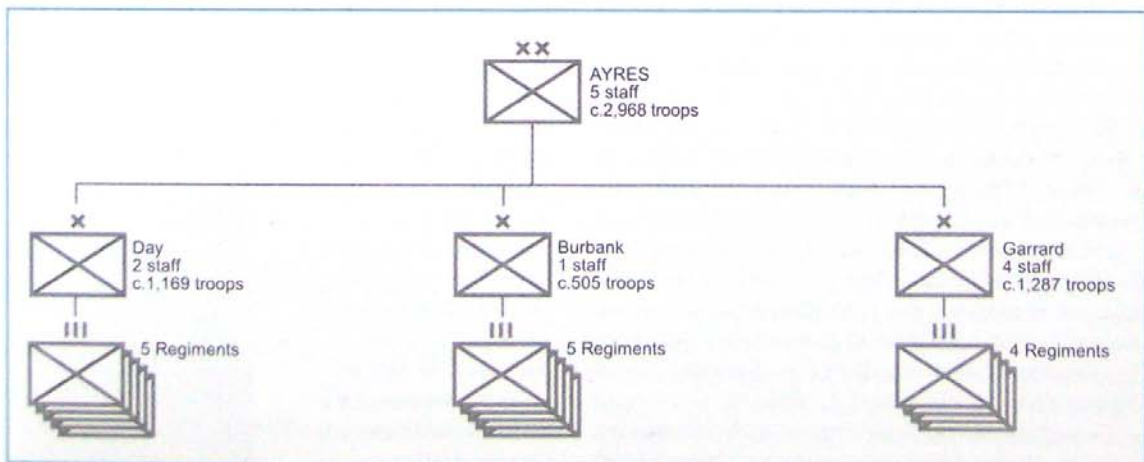

SECOND DIVISION

Brigadier-General Romeyn Beck Ayres
(division deployed but not engaged on July 3)

FIRST BRIGADE**Colonel Hannibal Day**

3rd United States Regiment of Infantry
(Total casualties: 74)

Captain Richard Gregory Lay

4th United States Regiment of Infantry
(Total casualties: 40)

Captain Julius Walker Adams, Jr.

6th United States Regiment of Infantry
(Total casualties: 44)

Captain Levi Clarke Bootes

12th United States Regiment of Infantry
(Total casualties: 92)

Captain Thomas Searle Dunn

14th United States Regiment of Infantry
(Total casualties: 132)

Major Grotius Reed Giddings

SECOND BRIGADE**Colonel Sidney Burbank**

2nd United States Regiment of Infantry
(Total casualties: 67)

Major Arthur Tracy Lee

7th United States Regiment of Infantry
(Total casualties: 59)

Captain David Porter Hancock

10th United States Regiment of Infantry
(Total casualties: 51)

Captain William Clinton

11th United States Regiment of Infantry
(Total casualties: 120)

Major DeLancey Floyd-Jones

17th United States Regiment of Infantry
(Total casualties: 150)

Lieutenant-Colonel J. Durell Greene

THIRD BRIGADE**Colonel Kenner Garrard**

140th Regiment New York State Volunteers
(Monroe County Regiment) (Total casualties: 243)

Lieutenant-Colonel Louis Ernst

146th Regiment New York State Volunteers
(Garrard's Tigers) (Total casualties: 243)

Lieutenant-Colonel David T. Jenkins

91st Regiment Pennsylvania Volunteer Infantry
(Total casualties: 243)

Lieutenant-Colonel Joseph Hill Sinex

155th Regiment Pennsylvania Volunteer Infantry
(Total casualties: 243)

Lieutenant-Colonel John Herron Cain

Following Weed's commitment, the two brigades of regulars received orders to support Caldwell's counter-attack into the Wheatfield. The desperate encounter around the Wheatfield cost the regulars dearly. The 1st Brigade suffered 363 killed and wounded along with 18 missing. The 2nd Brigade endured heavier losses amounting to 420 killed and wounded and 27 missing. In total, amongst the 57 companies of regulars who fought on July 2, one in three men became a casualty. Most of the losses occurred when rebel troops poured around the flanks and compelled the regulars to retreat through a gauntlet of fire. The regulars rallied north of Little Round Top. Their involvement at Gettysburg was over.

Divisional commander Ayres continued to lead the division until replaced by Brigadier-General Charles Griffin during the army-wide reorganisation in 1864. Thereafter, he transferred to the Army of the James, where he commanded a division until the war's end.

V Corps – 3rd Division**The Pennsylvania Reserve Division**

About 2,800 men belonging to Brigadier-General Samuel Crawford's 3rd Division brought up the rear of V Corps as it marched towards the Union left on July 2. It arrived on the northeast slopes of Little Round Top at about 1600 hrs. Subsequently it shifted twice until it eventually occupied a position on the northwest slope, where it replaced Ayres' Division. Colonel Joseph Fisher's 3rd Brigade formed the first line. Behind it stood Colonel William McCandless' 1st Brigade.

Throughout July 2, Federal commanders reacted to a series of staggering rebel assaults. This caused

Brigadier-General Samuel Wylie Crawford and his division did not see heavy action at Gettysburg. Although his tendency to overstate his military achievements detracted from his reputation, he ably led his division through the remainder of the war. (USAMHI, Carlisle)



THIRD DIVISION

Brigadier-General Samuel Wylie Crawford
(division deployed but not engaged on July 3)

FIRST BRIGADE

Colonel William McCandless

30th Regiment Pennsylvania Volunteer Infantry
(1st Pennsylvania Reserves) (Total casualties: 46)
Colonel William Cooper Talley
31st Regiment Pennsylvania Volunteer Infantry
(2nd Pennsylvania Reserves) (Total casualties: 37)
Lieutenant-Colonel George Abisha Woodward
35th Regiment Pennsylvania Volunteer Infantry
(6th Pennsylvania Reserves) (Total casualties: 24)
Lieutenant-Colonel Wellington Harry Ent
42nd Regiment Pennsylvania Volunteer Infantry
(13th Pennsylvania Reserves) (Total casualties: 48)
Major William Ross Hartshorne

THIRD BRIGADE

Colonel Joseph W. Fisher

34th Regiment Pennsylvania Volunteer Infantry
(5th Pennsylvania Reserves) (Total wounded: 2)
Lieutenant-Colonel George Dare
38th Regiment Pennsylvania Volunteer Infantry
(9th Pennsylvania Reserves) (Total wounded: 5)
Lieutenant-Colonel James M'Kinney Snodgrass
39th Regiment Pennsylvania Volunteer Infantry
(10th Pennsylvania Reserves) (Total casualties: 5)
Colonel Adoniram Judson Warner
40th Regiment Pennsylvania Volunteer Infantry
(11th Pennsylvania Reserves) (Total casualties: 41)
Colonel Samuel McCartney Jackson
41st Regiment Pennsylvania Volunteer Infantry
(12th Pennsylvania Reserves) (Total casualties: 2)
Colonel Martin Davis Hardin

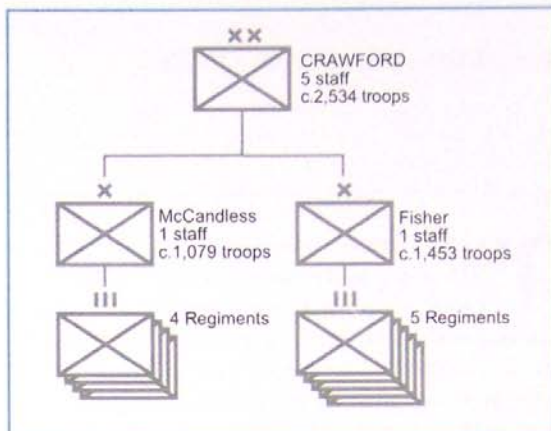

entire battle it lost only 1 officer and 5 enlisted men killed; 3 officers and 46 enlisted men wounded and none missing or captured. Forty-one of these 55 casualties occurred in the 11th Pennsylvania Reserves. All that remained was to glean the field. Fisher reported that his brigade secured over 1,000 small-arms and 'brought off over 200 wounded rebels, and buried 80 of their dead'.

The 1st Brigade, in association with the 11th Pennsylvania Reserves, experienced more action. They faced Plum Run and saw the Regular brigades retreating towards them. Crawford described the scene: 'The plain to my front was covered with fugitives from all divisions, who rushed through my lines ... Fragments of regiments came back in disorder, and without their arms, and for a moment all seemed lost. The enemy's skirmishers had reached the foot of the rocky ridge [Little Round Top]; his columns were following rapidly.'

McCandless' Brigade waited until its front cleared and delivered a volley and charged downslope. Its momentum carried away all opposition until the soldiers reached a stone wall. However, a galling fire against the brigade's left inflicted losses, including Colonel Charles Taylor of the 13th Pennsylvania Reserves. During its charge the brigade lost 151 men killed and wounded and 2 missing. This relatively light loss rate amounted to about 12 percent.

On July 3 the brigade continued to hold its advanced position behind the stone wall. Although it was further west, and thus closer to the Confederates, than any other Union battle line along the long shank of the fish-hook-shaped position, the brigade faced only sharpshooter fire during the day.

The division as a whole neither participated in the fighting nor suffered the losses of most other units. None the less, Crawford immodestly boasted about its exploits until his dying day.

divisional fragmentation, and so it proved for the 3rd Division. Corps commander General Sykes ordered Crawford to send a brigade to help the defenders of Little Round Top. Fisher's Brigade dutifully marched up slope and entered the line on Vincent's left. However, by the time they arrived, the fighting had ended.

After nightfall the brigade ascended Big Round Top. The climb was arduous but there was little opposition. Soldiers secured over 30 prisoners during their advance. The brigade held a position straddling the ravine between Big Round Top and Little Round Top the next day. Again it did not seriously engage. For the

Congressional Medal of Honor

Name: James B. Thompson

Rank: Sergeant

Unit: Co. G, 42nd Regiment Pennsylvania Volunteers Infantry

Date: July 3 1863

Citation: Capture of flag of 15th Georgia Infantry (C.S.A.).

V Corps Artillery Brigade

The five batteries assigned to support V Corps entered the field between 1600 and 1700 hrs on July 2. Three batteries trailed the 1st Division and two marched behind the 2nd Division. Battery D, 5th U.S., moved up the slope of Little Round Top and unlimbered. It delivered effective enfilade fire against the rebel infantry in the area of the Wheatfield. In turn, its gunners became the target of Confederate sharpshooters hidden in the rocks of the Devil's Den. The rebels picked out the mounted officers atop the heights.

The commanding officer, First Lieutenant Charles Hazlett, rode over to comfort General Weed, who had just been hit by a musket ball. While kneeling beside Weed, Hazlett received a mortal wound to his head. First Lieutenant Benjamin Rittenhouse assumed command of the battery.

The remaining artillery was mishandled. Throughout the afternoon, senior officers and staff officers coursed the field to direct units to plug holes in a desperate effort to stem the rebel tide. These activities broke up unit integrity. So it was with Battery C, 3rd Massachusetts, and Battery I, 5th U.S. An officer on Sickles' staff ordered both units to a position to support III Corps. Consequently, as the commander of V Corps Artillery Brigade reported, they were unavailable when called upon to support V Corps'

infantry. During the day, the Massachusetts battery had six men slightly wounded.

Battery I, 5th U.S., found itself without any support facing a Confederate infantry charge. The battery opened with shell fire at a range of 350 yards. Second Lieutenant MacConnell, who replaced the wounded Lieutenant Watson, reported, 'As they approached nearer, the battery poured in canister ... until men and horses were shot down or disabled to such an extent that the battery was abandoned.' A subsequent Union counter-attack reclaimed the guns. This regular battery suffered 22 casualties along with 41 horses. On July 3 it withdrew from the field to refit.

Battery L, 1st Ohio, was only lightly engaged on July 2. Two sections fired from positions on the slopes of Little Round Top. Two of the gunners received severe wounds.

Battery C, 1st New York, occupied a reserve position to the right of Battery L. Since Union infantry remained in front of the battery, it never had an open field of fire and did not fire a shot or suffer any losses.

On July 3, Battery C, 3rd Massachusetts, and Battery C, 1st New York, moved to the army's extreme left. Here, behind Big Round Top, they supported some VI Corps infantry and did not become engaged. In contrast, Rittenhouse's battery delivered deadly enfilade fire against Pickett's men.

V CORPS ARTILLERY BRIGADE

Captain Augustus P. Martin

Battery C, 3rd Massachusetts Light Artillery

Lieutenant Aaron Francis Walcott
(115 troops present for duty equipped)
(Total wounded: 6)
6 x 12-pounder Napoleon guns

Battery C, 1st New York Light Artillery

Captain Almont Barnes
(62 troops present for duty equipped)
(Total casualties: 0)
4 x 3-inch rifled guns

Battery L, 1st Ohio Light Artillery

Captain Frank Charles Gibbs
(113 troops present for duty equipped)
(Total wounded: 2)
6 x 12-pounder Napoleon guns

Battery D, 5th United States Artillery

Lieutenant Benjamin Franklin Rittenhouse
(68 troops present for duty equipped)
(Total casualties: 13)
6 x 10-pounder Parrott rifled guns

Battery I, 5th United States Artillery

Lieutenant-Colonel Charles Curtis MacConnell
(71 troops present for duty equipped)
(Total casualties: 22)
4 x 3-inch rifled guns

THE ARMY OF THE POTOMAC

VI CORPS

VI Corps completed an epic speed march of more than 30 miles to reach the battlefield on the afternoon of July 2. Operating from a reserve position, various units helped buttress the Union line during the remainder of the battle. The entire corps lost 2 officers and 25 men killed, 14 officers and 171 men wounded, and 30 enlisted men missing. Given that VI Corps was the army's strongest, this total of 242 casualties was extraordinarily light. As Major-General John Sedgwick reported, 'The troops were more or less exposed to the fire of the enemy's



VI CORPS

Major-General John Sedgwick

13 Staff and Field Officers

First Division

Brigadier-General Horatio Gouverneur Wright

Second Division

Brigadier-General Albion Parris Howe

Third Division

Brigadier-General Frank Wheaton

VI Corps Artillery

Colonel Charles H. Tompkins

artillery, but, with the exception of the evening of July 2, they were at no time seriously engaged.'

The corps' greatest contribution was the security it provided for General Meade. In addition, Sedgwick lent a stolid presence. A staff officer saw Sedgwick at Meade's council of war and left this description: 'A heavy man, short, thick-set and muscular, with florid complexion, dark, calm, straight-looking eyes, with full, heavyish features which, with his eyes, have plenty of animation when he is aroused ... Like Meade, he looks and is, honest and modest. You might see at once, why his men, because they love him, call him Uncle John.'

Early in the morning General Newton appeared to at Sedgwick's headquarters to ask him for men to help plug a gap on the left-centre of Cemetery Ridge. Curiously, Sedgwick claimed he could only spare one brigade. What threats he perceived were confronting him can only be guessed at. Sedgwick sent Torbert's New Jersey Brigade to Newton's assistance. Torbert extended the Union line on Cemetery Ridge by

The main body of the powerful VI Corps served as an emergency reaction force on July 3, to counter any possible assault from McLaw's Division along the Wheatfield Road.



Meade used VI Corps as his strategic reserve on July 3 at Gettysburg, leaving Major-General John Sedgwick with little to do. 'I might as well go home,' the disappointed corps commander commented. (USAMHI, Carlisle)

deploying to the left of Caldwell's Division.

During the Battle of Gettysburg, the presence of the VI Corps provided Meade with a priceless reserve. Having seen the army suffer from Lee's unexpected attacks, he retained it to meet emergencies. The dispersal of his corps as Meade assigned brigades to various sectors disappointed Sedgwick. Whether VI Corps could have delivered a telling counter-attack on July 3 after the repulse of the Confederate charge remains one of the battle's great questions.

VI CORPS — GETTYSBURG — July 3

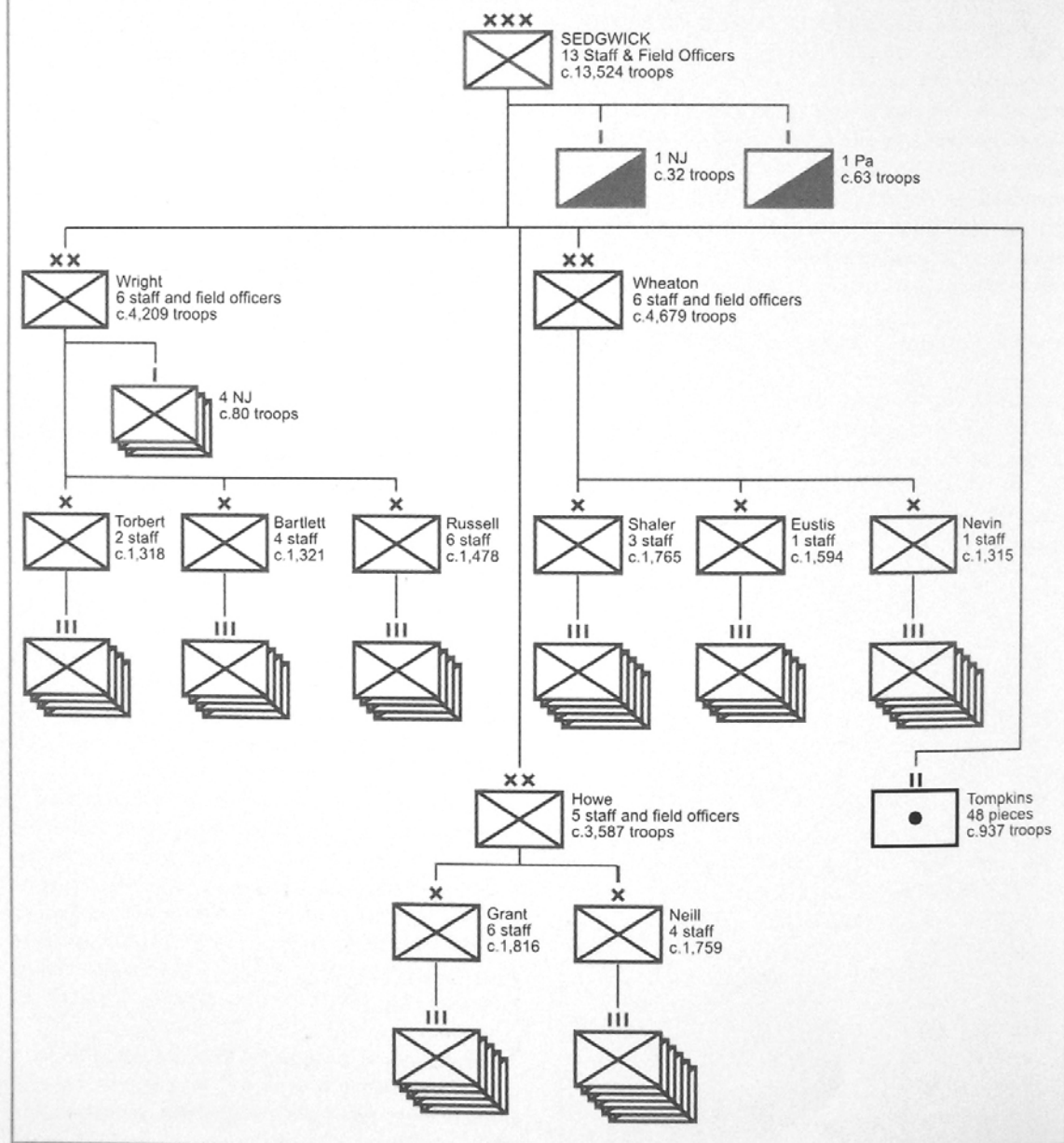



Brigadier-General Horatio Wright's 1st Division was one of the army's numerically strongest divisions. It arrived on the field via the Baltimore Pike after 1700 hrs on July 2. After resting for about an hour, it moved to assist the army's left. It

Brigadier-General Horatio Gouverneur Wright, after an uneventful time at Gettysburg, continued to lead his division until his promotion to corps command the following year. He ended his military career in 1884 as Chief Engineer of the army.

(USAMHI, Carlisle)



was too late to participate in the combat.

Early the next morning, Wright received a special assignment to guard the army's deep left-rear. The units detailed for this included his own 3rd Brigade, under Brigadier-General David Russell, which was supported by Colonel Lewis Grant's brigade from the 2nd Division. This command was deployed to the east of Big Round Top, facing southwest, to protect against any deep, enveloping, Confederate flank-attack. The men passed an uneventful day.

Also on July 3, corps commander Sedgwick ordered the deployment of Torbert's 1st Brigade in a position just north of Little Round Top and astride the Wheatfield Road. Bartlett's 2nd Brigade was deployed immediately to the rear of the 1st Brigade to provide support. These brigades would counter any attack from McLaws' division, around Stoney Hill, aimed at driving a wedge between the Round Tops and Cemetery Ridge. However, no such attack came. The

1st DIVISION HEADQUARTERS

PROVOST GUARD

Cos. A, C & H, 4th New Jersey Volunteer Infantry Regiment
Major Charles Ewing
80 troops present for duty equipped

FIRST DIVISION

Brigadier-General Horatio Gouverneur Wright

(division deployed but not engaged on July 3)

FIRST BRIGADE (The New Jersey Brigade)

Brigadier-General Alfred Thomas Archimedes Torbert

1st New Jersey Volunteer Infantry Regiment

(Total casualties: 0)

Lieutenant-Colonel William Henry, Jr.

2nd New Jersey Volunteer Infantry Regiment

(Total wounded: 6)

Lieutenant-Colonel Charles Wiebecke

3rd New Jersey Volunteer Infantry Regiment

(Total wounded: 2)

Lieutenant-Colonel Edward L. Campbell

15th New Jersey Volunteer Infantry Regiment

(Total wounded: 3)

Colonel William Henry Penrose

SECOND BRIGADE

Brigadier-General Joseph Jackson Bartlett

5th Regiment Maine Volunteer Infantry

(Total casualties: 0)

Colonel Clark Swett Edwards

121st Regiment New York State Volunteers

(Otsego & Herkimer Regiment) (Total wounded: 2)

Colonel Emory Upton

95th Regiment Pennsylvania Volunteer Infantry

(Total casualties: 2)

Lieutenant-Colonel Edward Carroll

96th Regiment Pennsylvania Volunteer Infantry

(Total wounded: 1)

Major William H. Lessig

THIRD BRIGADE

Brigadier-General David Allen Russell

6th Regiment Maine Volunteer Infantry

(Total casualties: 0)

Colonel Hiram Burnham

49th Regiment Pennsylvania Volunteer Infantry

(Total casualties: 0)

Lieutenant-Colonel Thomas Marcus Hulings

119th Regiment Pennsylvania Volunteer Infantry

(Total casualties: 0)

Colonel Peter Clarkson Ellmaker

5th Wisconsin Infantry Regiment

(Total casualties: 2)

Colonel Thomas Scott Allen

entire division lost only one man killed and 17 wounded at Gettysburg.

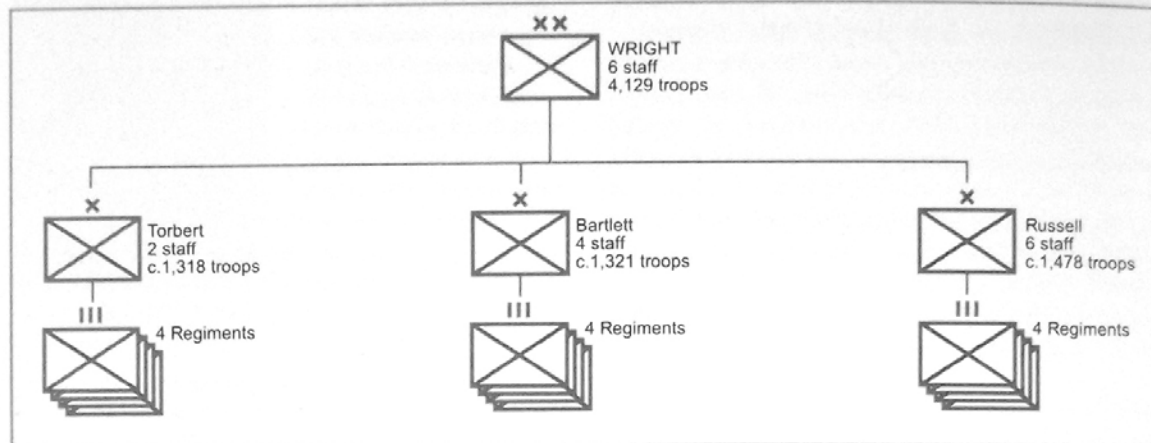

VI Corps – 2nd Division



The 2nd Division, commanded by Brigadier-General Albion Howe, comprised only two brigades and was the weakest in the corps. It was the last to arrive on the field, trailing the line of march of its sister divisions on the Baltimore Pike.

Grant's all-Vermont 2nd Brigade received the assignment of securing the army's left-rear. It occupied a position facing southwest between Big Round Top and the Taneytown Road. It maintained this position

throughout July 3, when Russell's brigade from the 1st Division joined it. Although a few long-range artillery shots fell amidst its ranks, it did not engage.

The division's 3rd Brigade was assigned the opposite end of the line. It occupied the army's extreme right between Culp's Hill and Powers' Hill and lightly skirmished. Had the Army of Northern Virginia delivered one of its trademark deep envelopments, these brigades would have become prominently

SECOND DIVISION

Brigadier-General Albion Parris Howe

(division deployed but not engaged on July 3)

SECOND BRIGADE

Colonel Lewis Addison Grant

2nd Regiment Vermont Volunteers

(Total casualties: 0)

Colonel James H. Walbridge

3rd Regiment Vermont Volunteers

(Total casualties: 0)

Colonel Thomas Orville Seaver

4th Regiment Vermont Volunteers

(Total wounded: 1)

Colonel Charles Bradley Stoughton

5th Regiment Vermont Volunteers

(Total casualties: 0)

Lieutenant-Colonel John Randolph Lewis

6th Regiment Vermont Volunteers

(Total casualties: 0)

Colonel Elisha L. Barney

THIRD BRIGADE

Brigadier-General Thomas Hewson Neill

7th Regiment Maine Volunteer Infantry (Total wounded: 6)

Lieutenant-Colonel Selden Connor

33rd Regiment New York State Volunteers

(Ontario Regiment) (Total casualties: 0)

Captain Henry Judson Gifford

43rd Regiment New York State Volunteers

(Albany & Yates' Rifles) (Total casualties: 5)

Lieutenant-Colonel John Wilson

49th Regiment New York State Volunteers

(2nd Buffalo Regiment) (Total wounded: 2)

Colonel Daniel Davidson Bidwell

77th Regiment New York State Volunteers

(Saratoga Regiment) (Total casualties: 0)

Lieutenant-Colonel Winsor Brown French

61st Regiment Pennsylvania Volunteer Infantry

(Total casualties: 2)

Lieutenant-Colonel George Fairlamb Smith

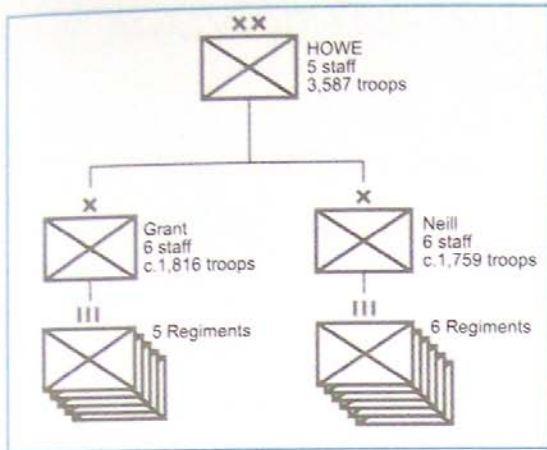

VI Corps – 3rd Division



Because it led the corps onto the field, the 3rd Division was the only VI Corps unit to engage significantly at Gettysburg. It arrived via the Baltimore Pike at about 1700 hrs on July 2 and Brigadier-General Wheaton received orders to send his leading two brigades to buttress the Union left.

On July 3 the division's two brigades deployed to the east of the Throstle House and north of the Wheatfield Road. Neither was engaged on July 3. For the entire battle the division lost only 1 officer and 19 enlisted men killed, with 12 officers and

136 enlisted men wounded and 28 more missing.

THIRD DIVISION

Brigadier-General Frank Wheaton

(division deployed but not engaged on July 3)

FIRST BRIGADE

Brigadier-General Alexander Shaler

- 65th Regiment New York State Volunteers (1st Grenadier Regiment) (Total casualties: 9)
- Colonel Joseph Eldridge Hamblin
- 67th Regiment New York State Volunteers (Long Island Regiment) (Total casualties: 1)
- Colonel Nelson Cross
- 122nd Regiment New York State Volunteers (Onondagas Regiment) (Total casualties: 44)
- Colonel Silas Titus
- 23rd Regiment Pennsylvania Volunteer Infantry (Total casualties: 14)
- Lieutenant-Colonel John Francis Glenn
- 82nd Regiment Pennsylvania Volunteer Infantry (Total wounded: 6)
- Colonel Isaac Clark Mifflin Bassett

SECOND BRIGADE

Colonel Henry Lawrence Eustis

- 7th Regiment Massachusetts Volunteer Infantry (Total wounded: 6)
- Lieutenant-Colonel Franklin P. Harlow
- 10th Regiment Massachusetts Volunteer Infantry (Total casualties: 9)
- Lieutenant-Colonel Joseph Bailey Parson
- 37th Regiment Massachusetts Volunteer Infantry (Total casualties: 47)
- Colonel Oliver Edwards
- 2nd Rhode Island Regiment Volunteer Infantry (Total casualties: 7)
- Colonel Horatio Rogers, Jr.

THIRD BRIGADE

Colonel David J. Nevin

- 62nd Regiment New York State Volunteers (Anderson's Zouaves) (Total casualties: 12)
- Lieutenant-Colonel Theodore Burns Hamilton
- 93rd Regiment Pennsylvania Volunteer Infantry (Total wounded: 10)
- Major John Irwin Nevin
- 98th Regiment Pennsylvania Volunteer Infantry (Total wounded: 11)
- Major John Benedict Kohler
- 102nd Regiment Pennsylvania Volunteer Infantry
- Colonel John W. Patterson (Regiment guarding trains at Westminster)
- 139th Regiment Pennsylvania Volunteer Infantry (Total casualties: 19)
- Colonel Frederick Hill Collier/
- Lieutenant-Colonel William H. Moody

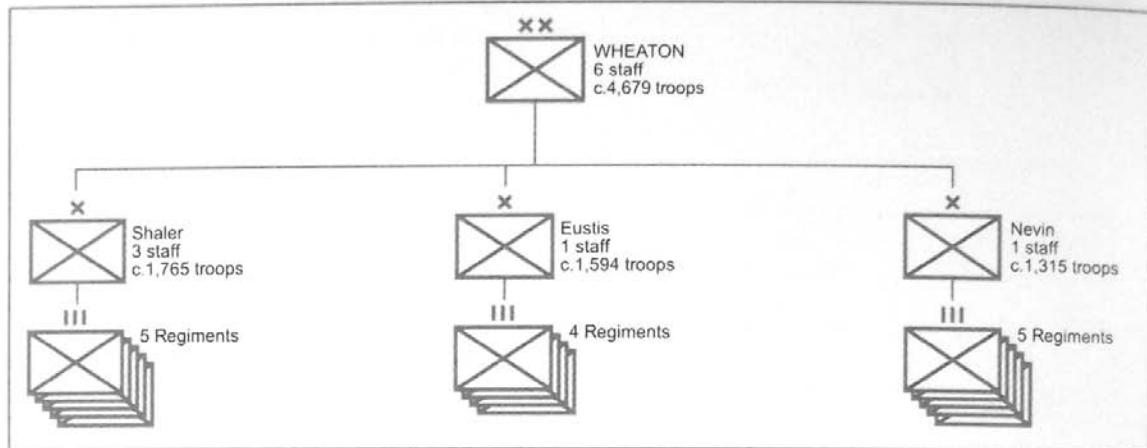

VI Corps Artillery Brigade

Like the infantry, VI Corps Artillery Brigade was neither employed in mass nor engaged prominently during the battle. Typical was the 1st Massachusetts Battery, which unlimbered on Cemetery Hill after the repulse of the rebel infantry. Its captain had to content himself with boasting about how much unused ammunition his battery salvaged.

In contrast, around noon on July 3 the 1st New York Battery moved at a brisk trot to Cemetery Hill and soon

thereafter became involved in a counter-battery duel. It then moved to support Webb's infantry. Here it faced the charging rebels: 'I commenced firing canister at 200 yards, and the effect was greater than I could have anticipated. My last [double] charge literally swept the enemy from my front, being fired at less than 20 yards.' Cowan's battery suffered the only losses among the brigade; 4 enlisted men killed, 2 officers and 6 enlisted men wounded.

VI CORPS ARTILLERY BRIGADE Colonel Charles H. Tompkins

1st Battery, Massachusetts Light Artillery

Captain William Henry McCartney
(135 troops present for duty equipped)
(Total casualties: 0)

6 x 12-pounder Napoleon guns

1st Battery, New York Light Artillery

Captain Andrew Cowan
(103 troops present for duty equipped)
(Total casualties: 12)

6 x 3-inch rifled guns

3rd Battery, New York Light Artillery

Captain William A. Harn
(111 troops present for duty equipped)
(Total casualties: 0)

6 x 10-pounder Parrott rifled guns

Battery C, 1st Rhode Island Light Artillery

Captain Richard Waterman
(116 troops present for duty equipped)
(Total casualties: 0)

6 x 3-inch rifled guns

Battery G, 1st Rhode Island Light Artillery

Captain George William Adams
(126 troops present for duty equipped)
(Total casualties: 0)

6 x 10-pounder Parrott rifled guns

Battery D, 2nd United States Artillery

Lieutenant Edward Bancroft Williston
(126 troops present for duty equipped)
(Total casualties: 0)

6 x 12-pounder Napoleon guns

Battery G, 2nd United States Artillery

Lieutenant John Hartwell Butler
(101 troops present for duty equipped)
(Total casualties: 0)

6 x 12-pounder Napoleon guns

Battery F, 5th United States Artillery

Lieutenant Leonard Martin
(116 troops present for duty equipped)
(Total casualties: 0)

6 x 10-pounder Parrott rifled guns

THE ARMY OF THE POTOMAC

XI CORPS

After two days of difficult combat, July 3 passed relatively uneventfully for XI Corps' infantry. The Confederate artillery bombardment pounded Cemetery Hill, inflicting some losses. During the height of the bombardment, Howard



Major-General Oliver Otis Howard's Corps suffered heavy losses at Gettysburg. On July 3, the corps held its positions on Cemetery Hill. Later in the war he was a creditable commander of the Army of the Tennessee.

(USAMHI, Carlisle)

Having broken on July 1 and 2, XI Corps did not face a Confederate infantry attack on July 3. Fortunately for the Union infantry, the Confederate high command had determined that Cemetery Hill was an impregnable position. On July 3, the corps held Cemetery Hill where it endured the rebel artillery bombardment, as well as deadly sharpshooter fire from marksmen concealed in the buildings on the outskirts of Gettysburg town.

XI CORPS HEADQUARTERS

PROVOST GUARD & ESCORT

Independent Co., 8th Regiment New York State Volunteers (1st German Rifles)

Lieutenant Hermann Foerster
(40 troops present for duty equipped)

Cos. I & K, 1st Regiment Indiana Cavalry

Captain Abraham Sharra
(50 troops present for duty equipped)

Co. K, 17th Regiment Pennsylvania Cavalry (162nd Volunteers)

Colonel Josiah H. Kellogg
(36 troops present for duty equipped)

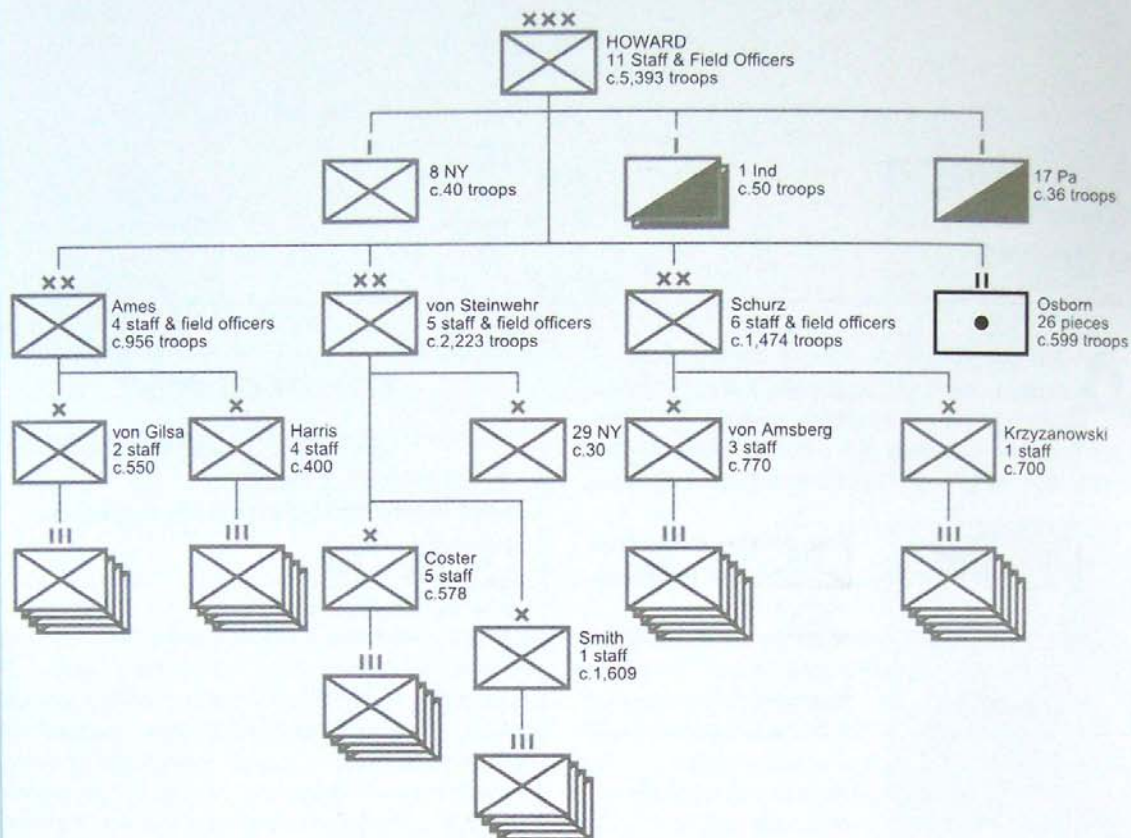

XI CORPS — GETTYSBURG — July 3

**XI CORPS***Major-General Oliver Otis Howard*

11 Staff and Field Officers

First Division

Brigadier-General Adelbert Ames

Second Division

Brigadier-General Adolph von Steinwehr

Third Division

Major-General Carl Schurz

XI Corps Artillery

Major Thomas W. Osborn

informed Meade, 'The fire has been concentrated upon this point about an hour, with no great effect. The batteries on our right do not reach us, and in the centre invariably overshoot us.'

XI Corps' Casualties at Gettysburg**July 3 1863**

Infantry killed or wounded 81

Infantry missing/captured 0

Artillery killed or wounded 10

Artillery missing/captured 0

XI Corps – 1st Division

Following the twilight struggle to defend the heights, the infantry of Ames' Division remained posted on the northeast slope of Cemetery Hill

on July 3. Although the morning skirmishing never approached a pitched battle, it still caused losses to those units assigned to outpost duty. Throughout the

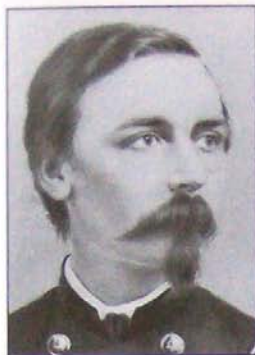

Brigadier-General Adelbert Ames returned to brigade command shortly after Gettysburg. After the war he served as military governor of Mississippi, eventually becoming its elected governor. Beset by corruption charges, he resigned in disgrace. (USAMHI, Carlisle)

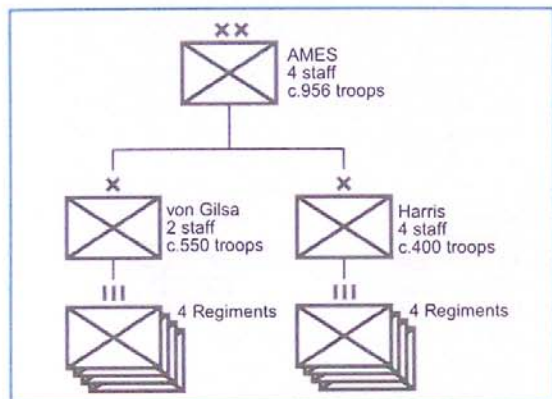

day the men endured sniping from rebels hidden in Gettysburg, and that afternoon suffered from the Confederate artillery bombardment.

XI Corps – 2nd Division

The 2nd Division defended the western slope of Cemetery Hill on July 3. Its forward skirmishers occupied positions along the Emmitsburg Road. The need to keep the rebel sharpshooters at a decent distance from the battle line required a substantial number of infantry in the picket line. The skirmishing began at first light on July 3. The colonel of the 136th New York reported, 'During the whole time we occupied this position, an almost continual conflict was kept up between the enemy's sharpshooters and ours.'

Although the infantry was not the particular target of the rebel artillery bombardment, this too inflicted some losses. General Howard described the scene: 'A terrific cannonade opened upon us from the west, northwest, north, and northeast, hurling into the cemetery grounds missiles of every description. Shells

On July 3, Brigadier-General Adolph Wilhelm August Frederick Baron von Steinwehr's Division held the most northern positions of the army, close to Gettysburg town. They were engaged only in skirmishing. (Carl Smith, Manassas)



burst in the air, in the ground to the right and left, killing horses, exploding caissons, overturning tombstones, and smashing fences. There was no place of safety.'

Because of its association with the July 1 débâcle, the division emerged from the battle with a tarnished

FIRST DIVISION

Brigadier-General Adelbert Ames
(division deployed but not engaged on July 3)

FIRST BRIGADE

Colonel Leopold von Gilsa
41st Regiment New York State Volunteers (DeKalb Regiment) (Total casualties: 75)
Lieutenant-Colonel Heinrich Detleo von Einsiedel
54th Regiment New York State Volunteers (Barney Black Rifles) (Total casualties: 102)
Lieutenant Ernst Both
68th Regiment New York State Volunteers (2nd German Rifles) (Total casualties: 138)
Colonel Gotthilf von Bourry d'Ivernois
153rd Regiment Pennsylvania Volunteer Infantry (Total casualties: 211)
Major John Frederick Frueauff

SECOND BRIGADE

Colonel Andrew Lintner Harris
17th Regiment Connecticut Infantry Volunteers (Total casualties: 197)
Major Allen G. Brady
25th Ohio Volunteer Infantry Regiment (Total casualties: 184)
Lieutenant Israel White
75th Ohio Volunteer Infantry Regiment (Total casualties: 186)
Captain George Benson Fox
107th Ohio Volunteer Infantry Regiment (Total casualties: 211)
Captain John Michael Lutz



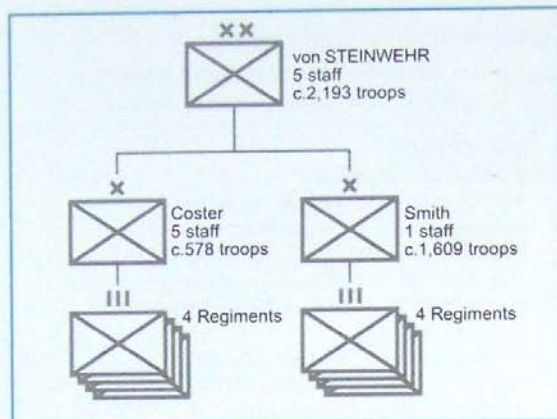

reputation. It would later redeem itself when it was transferred west.

Congressional Medals of Honor

Name: Richard Enderlin
Rank: Musician
Unit: Co. B, 73rd Ohio Volunteer Infantry Regiment
Date: 1–3 July 1863
Citation: Voluntarily took a rifle and served as a soldier in the ranks during the first and second days of the battle. Voluntarily and at his own imminent peril went into the enemy's lines at night, and under a sharp fire, rescued a wounded comrade.

Name: John Miller
Rank: Corporal
Unit: Co. G, 1st Regiment Delaware Volunteers
Date: July 3 1863
Citation: Capture of 2 flags.

SECOND DIVISION

**Brigadier-General Adolph Wilhelm August Frederick
 Baron von Steinwehr**

(division deployed but not engaged on July 3)

FIRST BRIGADE

Colonel Charles Robert Coster

134th Regiment New York State Volunteers
 (Total casualties: 252)
 Lieutenant-Colonel Allen Hyre Jackson
 154th Regiment New York State Volunteers
 (Total casualties: 200)
 Lieutenant-Colonel Daniel B. Allen
 27th Regiment Pennsylvania Volunteer Infantry
 (Total casualties: 111)
 Lieutenant-Colonel Lorenz Cantador
 73rd Regiment Pennsylvania Volunteer Infantry
 (Total casualties: 34)
 Captain Daniel F. Kelly

SECOND BRIGADE

Colonel Orland Smith

33rd Massachusetts Volunteer Infantry Regiment
 (Total casualties: 45)
 Colonel Adin Ballou Underwood
 136th Regiment New York State Volunteers
 (Ironclads) (Total casualties: 109)
 Colonel James Wood, Jr.
 55th Ohio Volunteer Infantry Regiment
 (Total casualties: 49)
 Colonel Charles B. Gambee
 73rd Ohio Volunteer Infantry Regiment
 (Total casualties: 145)
 Lieutenant-Colonel Richard Long

XI Corps – 3rd Division



On the evening of July 2, the 3rd Division engaged in spirited, close-range fighting and held its positions on Cemetery Hill. Its participation in the battle was over.

On July 3, the division occupied the northwestern slope of the hill in the middle of the corps' line. According to Major-General Schurz, 'no part of my command but my skirmishers were engaged'. The soldiers endured the Confederate artillery bombardment during the early afternoon but otherwise were inactive. The commander of the 45th New York related, 'Very little damage was done, however, to our ranks, and it proved only to be noisy. Whereas units like the 26th Wisconsin suffered no losses on July 3, the

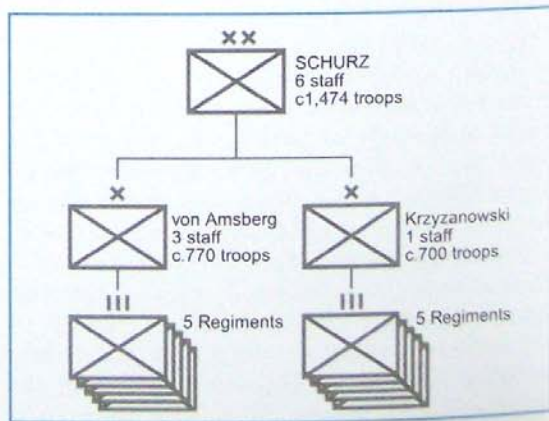

THIRD DIVISION

Major-General Carl Schurz

(division deployed but not engaged on July 3)

FIRST BRIGADE

Colonel George Karl Heinrich Wilhelm von Amsberg

82nd Illinois Infantry Regiment

Lieutenant-Colonel Edward Selig Salomon

45th Regiment New York State Volunteers

(5th German Rifles)

Lieutenant-Colonel Adolphus Dobke

157th Regiment New York State Volunteers

Colonel Philip Perry Brown, Jr.

61st Ohio Volunteer Infantry Regiment

Colonel Steven Joseph McGroarty

74th Regiment Pennsylvania Volunteers

Captain Henry Krauseneck

SECOND BRIGADE

Colonel Wladimir Krzyzanowski

58th Regiment New York State Volunteers

(Polish Legion)

Captain Emil Koenig

119th Regiment New York State Volunteers

Lieutenant-Colonel Edward F. Lloyd

82nd Ohio Volunteer Infantry Regiment

Lieutenant-Colonel David Thomson

75th Regiment Pennsylvania Volunteer Infantry

Major August Ledig

26th Wisconsin Infantry Regiment

Captain John William Fuchs

75th Pennsylvania had three casualties. At daybreak on July 4, the 58th New York had the satisfaction of re-entering Gettysburg. It captured over 280 prisoners.

Still, this small success did not erase the memory of the terrible July 1 drubbing and the division's subsequent rout through the streets.

XI Corps Artillery Brigade

The weary XI Corps gunners spent the night of July 2/3 making repairs and replenishing ammunition. The batteries did not change position. Because of the intermingling of I Corps and XI Corps batteries, Major Thomas Osborn, chief of artillery for XI Corps, retained command of the batteries west of the Baltimore Pike, while his counterpart in I Corps commanded those on the east side. Thus, Captain Wiedrich's Battery I, 1st New York Light Artillery, fell outside of Osborn's command. It continued to occupy the earthen lunettes behind Brickyard Lane facing northeast towards Benner's Hill. Just west of the Baltimore Pike was Captain Dilger's Battery I, 1st Ohio Light Artillery, with its six Napoleons. They were sited along the crest of Cemetery Hill in position to block any rebel charge issuing from the southern end of Gettysburg. On Dilger's left was a section from Taft's reserve artillery. Lieutenant Wheeler's 13th Battery, New York Light Artillery, with only three 3-inch rifles remaining, was in reserve behind Cemetery Hill. Heckman's depleted battery remained in the rear.

On July 3, all of the guns that could bear participated in the artillery duel, 'exhibiting great coolness, energy, and judgment', and then fired at the charging infantry, thereby helping to break the left part of the rebel assault force.

XI CORPS ARTILLERY BRIGADE

Major Thomas W. Osborn

Battery I, 1st New York Light Artillery

Captain Michael Wiedrich

(141 troops present for duty equipped)

(Total casualties: 13)

6 x 3-inch rifled guns

13th Battery, New York Light Artillery

Lieutenant William Wheeler

(110 troops present for duty equipped)

(Total casualties: 11)

3 x 3-inch rifled guns

Battery I, 1st Ohio Light Artillery

Captain Hubert Dilger

(127 troops present for duty equipped)

(Total casualties: 13)

6 x 12-pounder Napoleon guns

Battery K, 1st Ohio Light Artillery

Captain Lewis Heckman

(110 troops present for duty equipped)

(Total casualties: 15)

3 x 12-pounder Napoleon guns

Battery G, 4th United States Artillery

Lieutenant Eugene Adolphus Bancroft

(115 troops present for duty equipped)

(Total casualties: 17)

6 x 12-pounder Napoleon guns

THE ARMY OF THE POTOMAC

XII CORPS

The anomalous command structure within XII Corps persisted over the battle's third day. Major-General Henry Slocum continued to perceive that he was a wing commander. In fact, the need for a wing commander, if it had ever existed, had long since passed.

On July 3, Major-General Alpheus Williams actually commanded the corps. On the previous evening, when Slocum had learned that the

XII CORPS

Major-General Alpheus Starkey Williams
8 Staff and Field Officers

First Division

Brigadier-General Thomas Howard Ruger

Second Division

Brigadier-General John White Geary

XII Corps Artillery

Lieutenant Edward D. Muhlenberg

XII CORPS HEADQUARTERS

PROVOST GUARD & ESCORT

Cos. A, B & D, 10th Regiment Maine Volunteer Infantry
Captain John Davis Beardsley

169 troops present for duty equipped

Cos. D & L, 9th New York Volunteer Regiment of Cavalry
75 troops present for duty equipped

Brigadier-General Alpheus Starkey Williams performed well at Gettysburg, despite a confusing command situation. He gained fame after the war by publishing his wartime letters.

(MOLLUS-Pennsylvania)

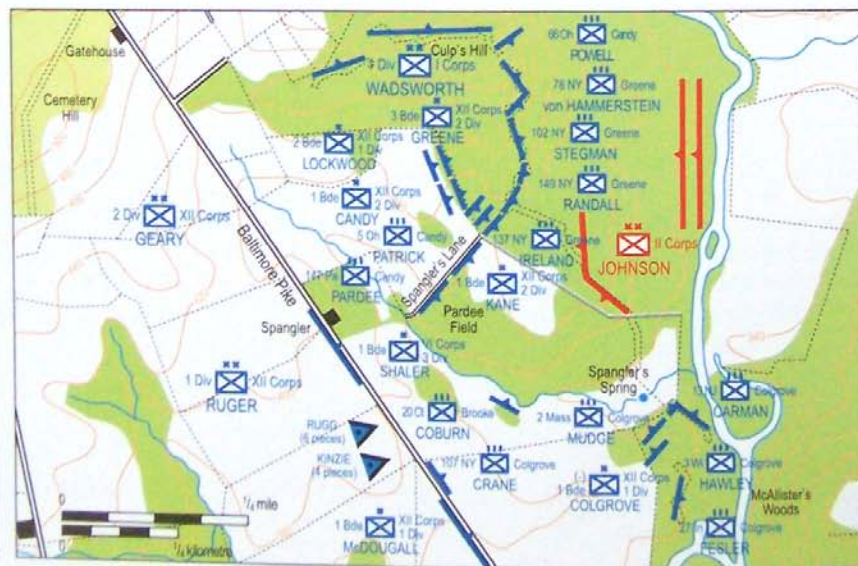

On the evening of July 2, two divisions from XII Corps had been ordered to the Union's left flank, but were not engaged. Due to some excellent staff work during the night, by dawn the corps had been reassembled on Culp's Hill. There, they would hold their ground and receive three separate assaults from Johnson's Confederates on July 3. The rebel attacks, although stoutly delivered, never seriously threatened Culp's Hill.

Confederates had established a lodgement within the Union lines on Culp's Hill, he had replied, 'Well, drive them out at daylight.' At least he did ensure that the two divisions, which had moved the previous day to support the Union left, returned to Culp's Hill.

Following Meade's council of war, Williams laboured all night to organise an infantry assault to

reclaim the lost line of breastworks along the lower section of Culp's Hill. Some time during the night, while Williams was meeting in the front lines with Colonel Colgrove, the latter urged an immediate attack. Williams disagreed, 'We will hold these positions we now have until morning. Then, from those hills back of us, we will shell hell out of them.'

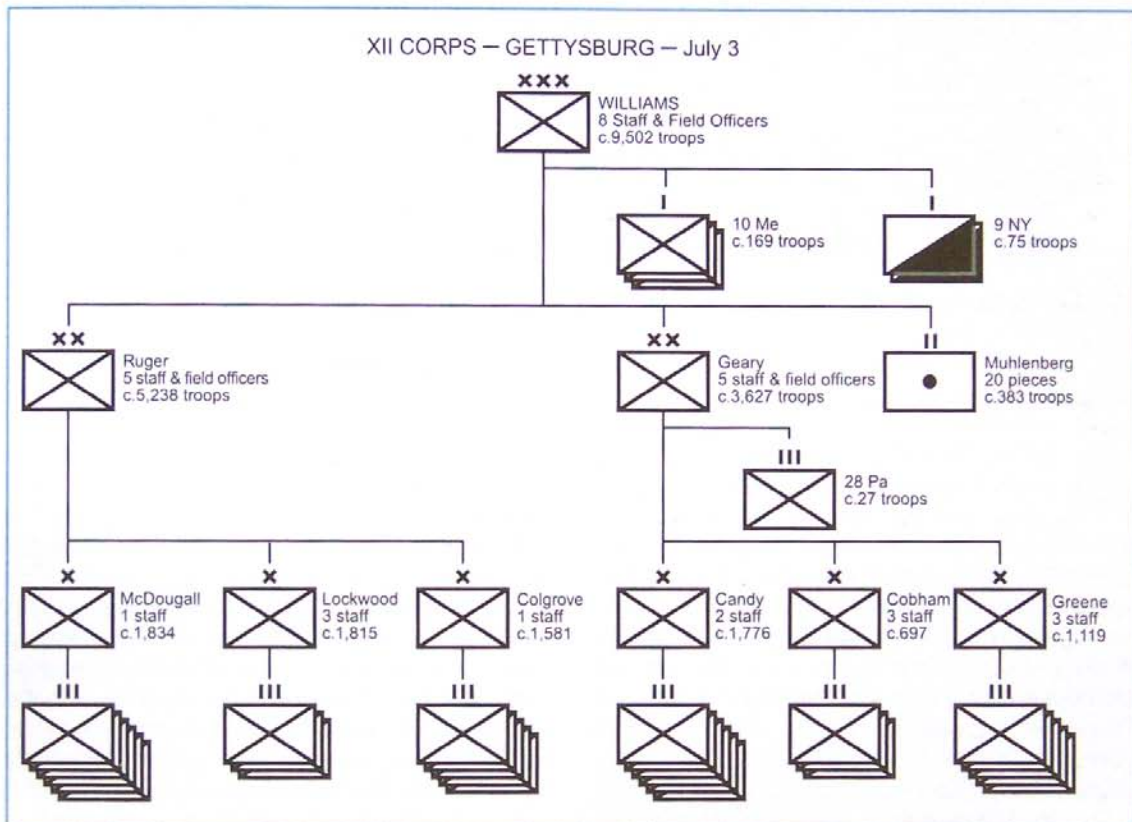

XII Corps – 1st Division



By virtue of Williams' ascension to corps command, Brigadier-General Thomas Ruger continued to command the 1st Division on July 3. All three of his brigades had yet to engage. The previous day had been spent holding the Union right until summoned to the left to assist the imperilled Union flank. The division made a moonlit return march to find the Confederates in possession of the lower section of Culp's Hill. Ruger judged a nocturnal assault unwise. He worked with Williams during the night to arrange artillery support for a dawn attack. At

FIRST DIVISION Brigadier-General Thomas Howard Ruger

- 1st Brigade – c.1,834 troops
- 2nd Brigade – c.1,815 troops
- 3rd Brigade – c.1,581 troops

daybreak Colgrove's Brigade was forward in McAllister's Woods while the other two brigades were aligned along the Baltimore Pike.

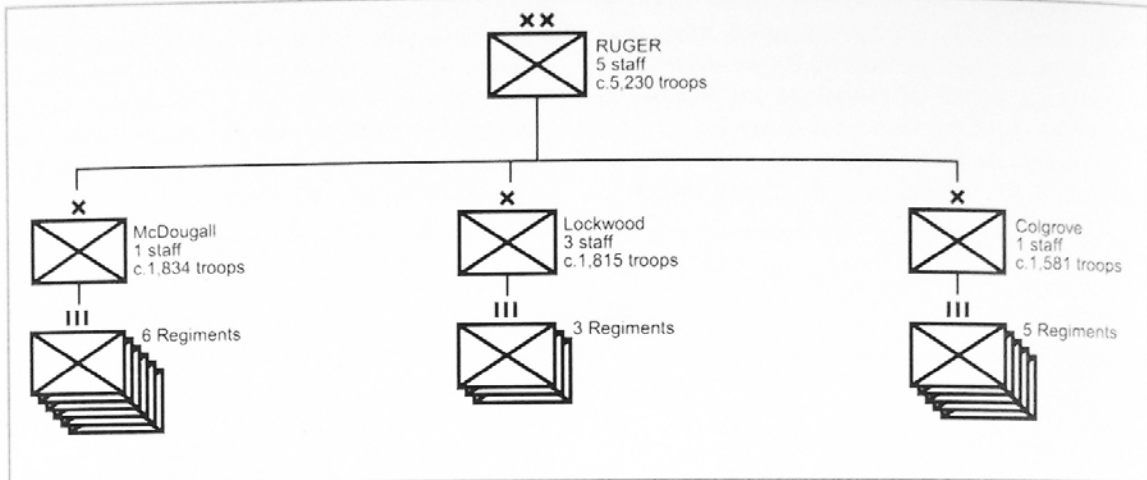

XII Corps – 1st Division – 1st Brigade

After the Chancellorsville Campaign, the terms of enlistment for many 1st Division regiments expired and the division's first two brigades were consolidated. The brigade lost its commander, Brigadier-General Joseph Knipe, when that officer was sent north to command a brigade of Pennsylvania militia. The brigade's senior colonel, Archibald McDougall, ascended to brigade command. Although McDougall had displayed fighting courage at Chancellorsville, while in command of the 123rd New York, that battle was his only previous combat

experience. McDougall had no prewar military training. Thus the newly consolidated brigade marched north under the command of an inexperienced leader. The 1st Brigade participated in the division's marching and counter-marching during July 1 and 2 but did not see combat. Late on the night of July 2, when nearing its former position on Culp's Hill, it crossed the Baltimore Pike and moved towards the south slope of Culp's Hill's lower crest. McDougall ordered two companies to probe ahead while the rest of the brigade formed in two lines. When the pickets encountered rebels, the brigade halted and remained in line of battle until dawn.

FIRST BRIGADE Colonel Archibald L. McDougall

5th Regiment Connecticut Infantry Volunteers
(Total casualties: 7)
Colonel Warren Wightman Packer
20th Regiment Connecticut Infantry Volunteers
(Total casualties: 28)
Lieutenant-Colonel William Burr Wooster
3rd Maryland Infantry Regiment
(Total casualties: 8)
Colonel Joseph M. Sudsbury
123rd Regiment New York State Volunteers
(Washington County Regiment) (Total casualties: 14)
Lieutenant-Colonel James Clarence Rogers
145th Regiment New York State Volunteers
(Stanton Legion) (Total casualties: 10)
Colonel Edward Livingston Price
46th Regiment Pennsylvania Volunteer Infantry
(Total casualties: 13)
Colonel James Levan Selfridge

5th Regiment Connecticut Infantry Volunteers
Colonel Packer
Cos. A through K.
20th Regiment Connecticut Infantry Volunteers
Lieutenant-Colonel Wooster
Cos. A through K.
3rd Maryland Infantry Regiment
Colonel Sudsbury
Cos. A through K.
123rd Regiment New York State Volunteers
(Washington County Regiment)
Lieutenant-Colonel Rogers
Cos. A through K.
145th Regiment New York State Volunteers
(Stanton Legion)
Colonel Price
Cos. A through K.
46th Regiment Pennsylvania Volunteer Infantry
Colonel Selfridge
Cos. A through K.

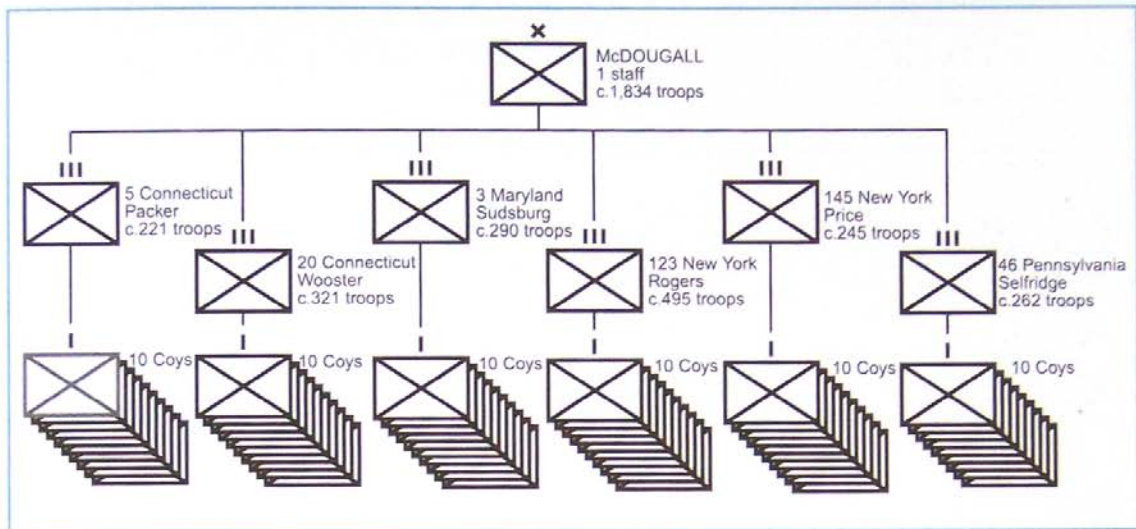

XII Corps – 1st Division – 2nd Brigade

The 1st Division's 2nd Brigade comprised three regiments which had been performing rear-area garrison duties. Because its commander, Brigadier-General Henry Lockwood, was senior to Brigadier-General Thomas Ruger, corps commander Williams made Lockwood's Brigade an independent command within the 1st Division. This preserved Lockwood's pride while permitting the able and experienced Ruger to retain divisional command.

On July 2, the brigade saw brief action when it marched to the Union left and counter-attacked against a force of rebels who were already retreating. It advanced triumphantly towards the Peach Orchard and reclaimed three abandoned Union guns. Upon its return to the Union right, it found the Confederates in

possession of its breastworks. It deployed along the Baltimore Pike and waited to take its place in the dawn assault. The 1st Maryland Eastern Shore Regiment did not reach the Pike until later in the morning of July 3. This regiment was unique in the army because its colonel, as well as some others, were slave owners.



Brigadier-General Henry Hayes Lockwood was a Mexican War naval veteran and instructor at the Naval Academy. He rejoined the army in May 1861 but did not see combat until he marched his troops to Gettysburg. (USAMHI, Carlisle)

SECOND BRIGADE

Brigadier-General Henry Hayes Lockwood

1st Maryland Potomac Home Brigade
(Total casualties: 25)
Colonel William Pinckney Maulsby
1st Maryland Eastern Shore Regiment
(Total casualties: 104)
Colonel James Wallace
150th Regiment New York State Volunteers
(Dutchess Legion) (Total casualties: 45)
Colonel John Henry Ketcham

1st Maryland Potomac Home Brigade

Colonel Maulsby
Cos. A through K.
1st Maryland Eastern Shore Regiment
Colonel Wallace
Cos. A through K.
**150th Regiment New York State Volunteers
(Dutchess Legion)**
Colonel Ketcham
Cos. A through K.

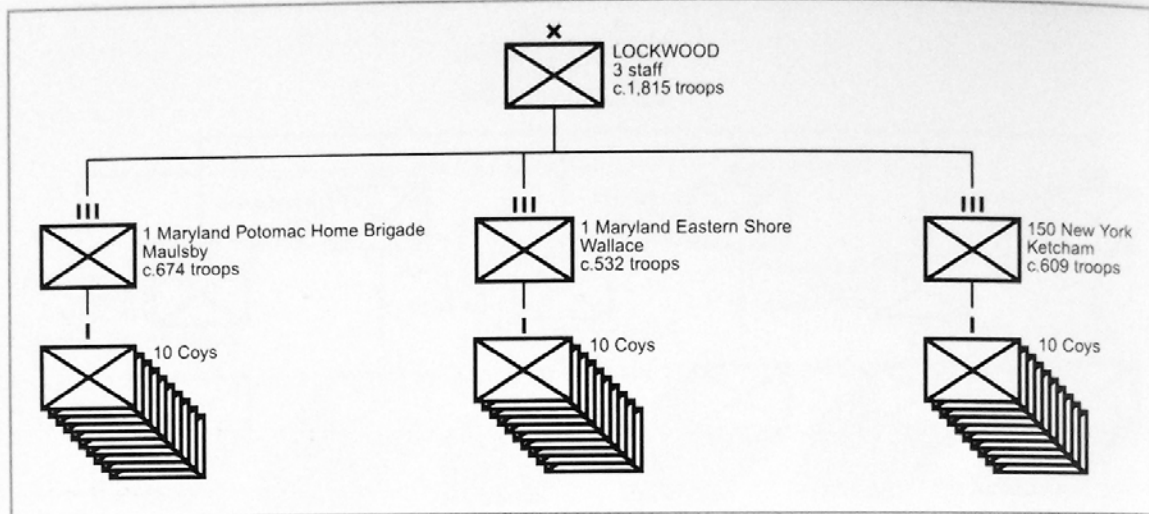

XII Corps – 1st Division – 3rd Brigade

The 1st Division's 3rd Brigade included some of the army's best veteran soldiers. Under the command of Thomas Ruger, the brigade had fought hard and well at Cedar Mountain and Antietam. At Chancellorsville it had particularly distinguished itself. Although surrounded on three sides, it drove back successive Confederate charges at tremendous cost, suffering 614 casualties.

With Ruger serving as divisional commander, Colonel Silas Colgrove commanded the brigade on 2 and July 3. It shared the division's march to the Union left on July 2 but did not engage. Upon

returning to Culp's Hill, the brigade saw that the rebels had occupied their vacated position. The brigade moved into McAllister's Woods overlooking Rock Creek during the night. Here it occupied a cramped, U-shaped position with the 2nd Massachusetts on the left, the 13th New Jersey in the middle, and Colgrove's own 27th Indiana on the right. The 3rd Wisconsin provided a brigade reserve.

The brigade's assignment for the dawn attack on July 3 was to cross the Spangler meadow and attack the line of breastworks, if the enemy was 'not in too great a force.' The difficulties of conducting a reconnaissance in force at first light, when the enemy was in close proximity, soon became apparent.

THIRD BRIGADE Colonel Silas Colgrove

27th Regiment Indiana Volunteer Infantry
(Total casualties: 110)
Lieutenant-Colonel John R. Fesler
2nd Regiment Massachusetts Volunteer Infantry
(Total casualties: 136)
Lieutenant-Colonel Charles Redington Mudge/
Major Charles Fessenden Morse
13th New Jersey Volunteer Infantry Regiment
(Total casualties: 21)
Colonel Ezra Ayres Carman
107th Regiment New York State Volunteers
(Campbell Guards) (Total wounded: 2)
Colonel Nirom Marium Crane
3rd Wisconsin Infantry Regiment (Total casualties: 10)
Colonel William Hawley

27th Regiment Indiana Volunteer Infantry
Lieutenant-Colonel Fesler
Cos. A through K.
2nd Regiment Massachusetts Volunteer Infantry
Lieutenant-Colonel Mudge
Cos. A through K.
13th New Jersey Volunteer Infantry Regiment
Colonel Carman
Cos. A through K.
**107th Regiment New York State Volunteers
(Campbell Guards)**
Colonel Crane
Cos. A through K.
3rd Wisconsin Infantry Regiment
Colonel Hawley
Cos. A through K.

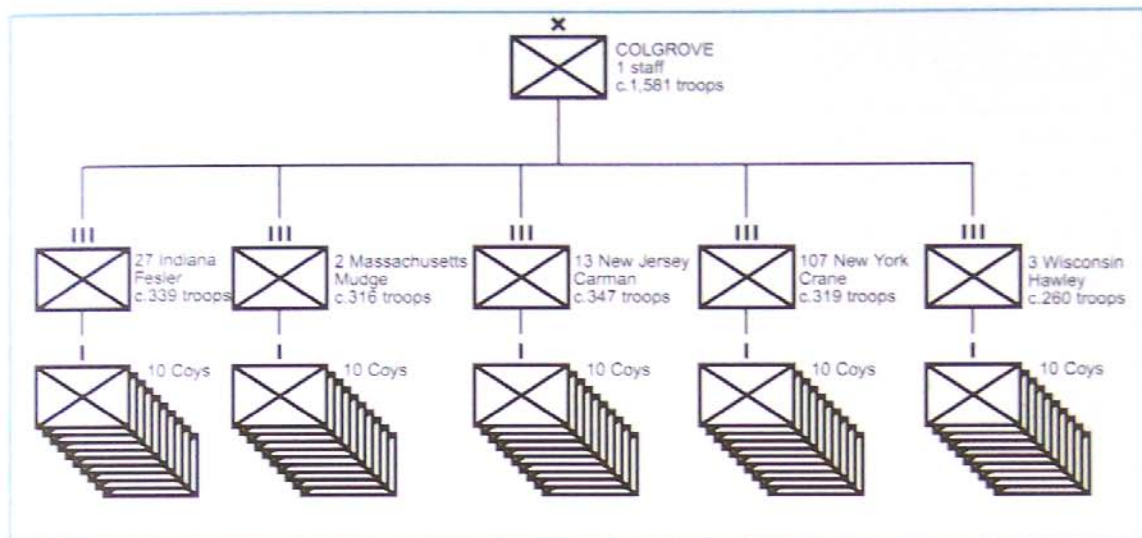

XII Corps – 2nd Division



On July 2, due to 'a singular blunder', two of the 2nd Division's brigades got lost while on the march to reinforce the Union left. Meanwhile,

SECOND DIVISION Brigadier-General John White Geary

1st Brigade – c. 1,776 troops
2nd Brigade – c. 697 troops
3rd Brigade – c. 1,119 troops

By July 3, Brigadier-General John White Geary's Division had reassembled on Culp's Hill. It would hold the right flank of the army. Geary remained in divisional command through the remainder of the war. He later served as governor of Pennsylvania. (MARS)

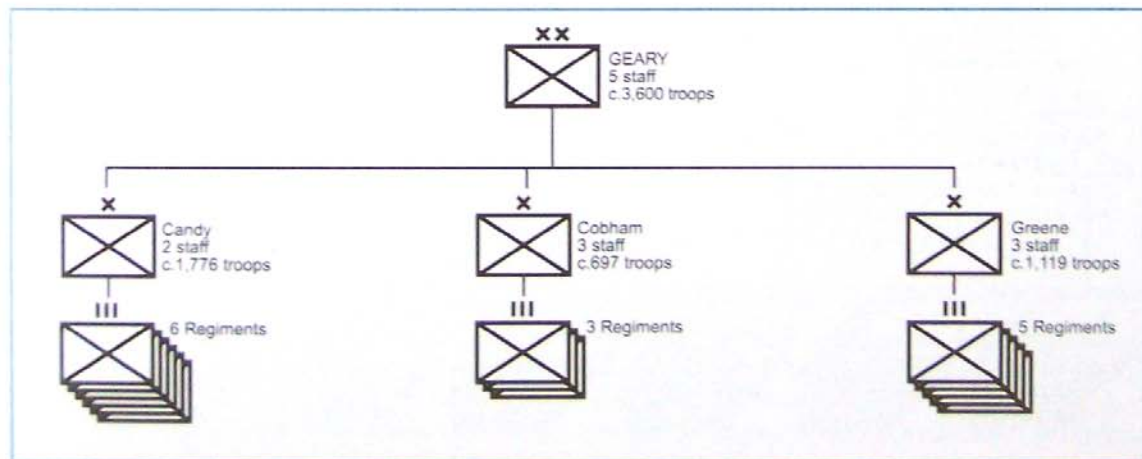

DIVISIONAL HEADQUARTERS

PROVOST GUARD

Co. B, 28th Regiment Pennsylvania Volunteer Infantry
27 troops present for duty equipped

the division's 3rd Brigade upheld the division's honour by stoutly defending Culp's Hill. By dawn of July 3, the entire division was reassembled in an improvised line covering the main crest of Culp's Hill. Here it would receive a ferocious Confederate assault from Johnson's troops.

XII Corps – 2nd Division – 1st Brigade

After spending the evening of July 2 in tiring marching and counter-marching, the rest of the night of July 2/3 was used to occupy positions

atop the main crest of Culp's Hill. It was difficult to align the regiments in the dark and rugged terrain while in close proximity to the enemy. The 28th Pennsylvania and 7th, 29th and 66th Ohio provided support to Greene's brigade. The 147th Pennsylvania and 5th Ohio faced southeast towards the Pardee Field.

FIRST BRIGADE Colonel Charles Candy

5th Ohio Volunteer Infantry Regiment
(Total casualties: 18)
Colonel John Halliday Patrick
7th Ohio Volunteer Infantry Regiment
(Total casualties: 18)
Colonel William R. Creighton
29th Ohio Volunteer Infantry Regiment
(Total casualties: 38)
Captain Wilber F. Stevens
66th Ohio Volunteer Infantry Regiment
(Total casualties: 17)
Lieutenant-Colonel Eugene Powell
28th Regiment Pennsylvania Volunteer Infantry
(Total casualties: 28)
Captain John Hornbuckle Flynn
147th Regiment Pennsylvania Volunteer Infantry
(Total casualties: 20)
Lieutenant-Colonel Ario Pardee, Jr.

5th Ohio Volunteer Infantry Regiment

Colonel Patrick
Cos. A through K.

7th Ohio Volunteer Infantry Regiment

Colonel Creighton
Cos. A through K.

29th Ohio Volunteer Infantry Regiment

Captain Stevens
Cos. A through K.

66th Ohio Volunteer Infantry Regiment

Lieutenant-Colonel Powell
Cos. A through K.

28th Regiment Pennsylvania Volunteer Infantry

Captain Flynn
Cos. A & C through K.

147th Regiment Pennsylvania Volunteer Infantry

Lieutenant-Colonel Pardee
Cos. A through H.

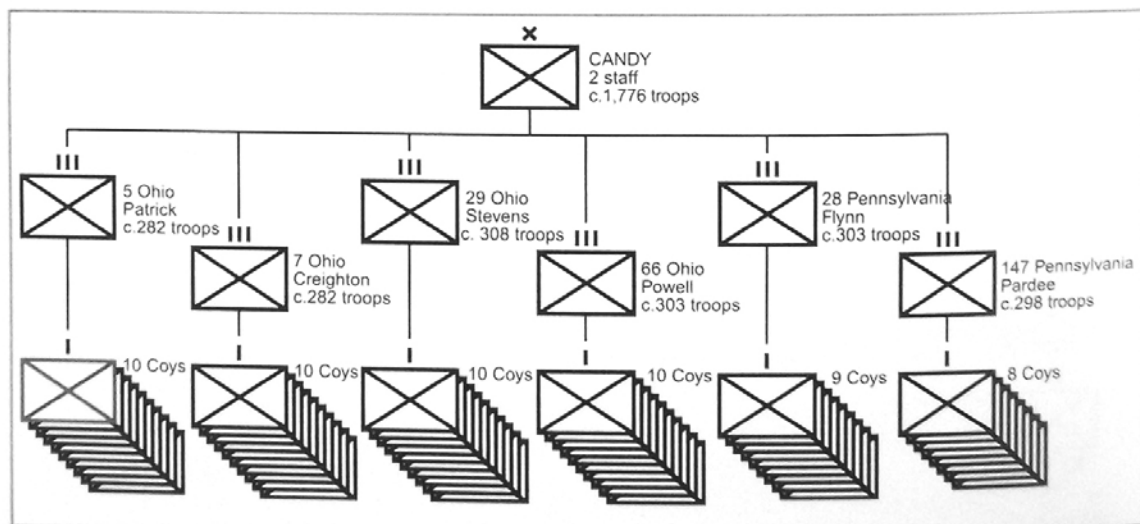

XII Corps – 2nd Division – 2nd Brigade

After suffering the least of the 2nd Division's brigades at Chancellorsville, the 2nd Brigade arrived at Gettysburg on July 1 and took up a reserve position. The next morning its commander, Brigadier-General Thomas Kane, though sick, rejoined the unit after making a hard journey from Philadelphia.

SECOND BRIGADE

Colonel George A. Cobham, Jr.

29th Regiment Pennsylvania Volunteer Infantry
(Total casualties: 66)

Colonel William Rickards, Jr.

109th Regiment Pennsylvania Volunteer Infantry
(Total casualties: 10)

Captain Frederick Louis Gimber

111th Regiment Pennsylvania Volunteer Infantry
(Total casualties: 22)

Lieutenant-Colonel Thomas McCormick Walker

Kane had heard about the impending battle and wanted to be with his men. However, he was so ill that brigade command alternated on July 2 and 3 between himself and his senior colonel, the English-born George Cobham, Jr. The 2nd Brigade, like the 1st, spent the night of July 2/3 struggling into position on Culp's Hill. When finally aligned, it held a position on the right flank of Greene's Brigade.

29th Regiment Pennsylvania Volunteer Infantry

Colonel Rickards

Cos. A through K.

109th Regiment Pennsylvania Volunteer Infantry

Captain Gimber

Cos. A through K.

111th Regiment Pennsylvania Volunteer Infantry

Lieutenant-Colonel Walker

Cos. A through K.

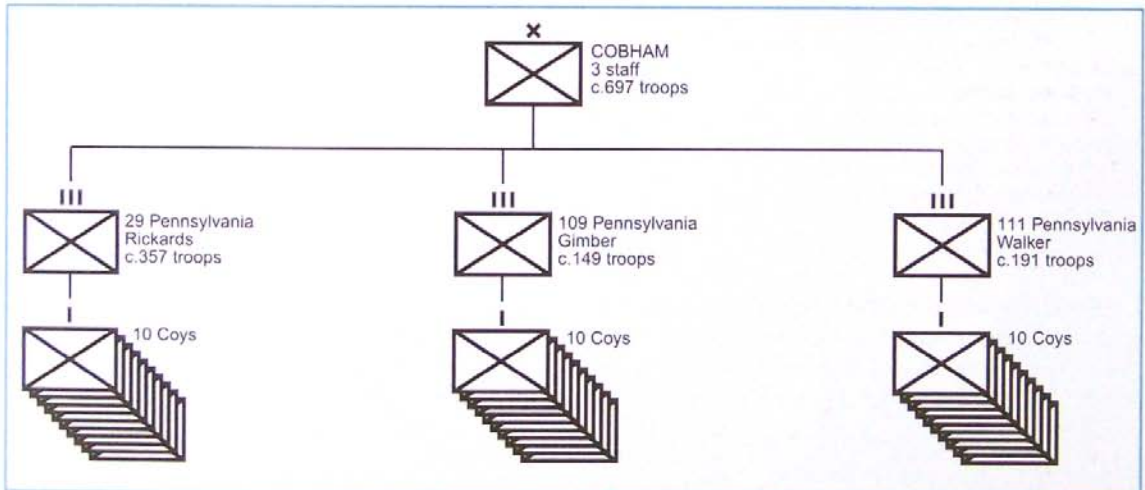

XII Corps – 2nd Division – 3rd Brigade

While the rest of XII Corps marched away to confront an imaginary threat on the Union left, the 3rd Brigade remained on Culp's Hill to resist a determined Confederate attack. On July 2, the brigade's tenacity saved the Union right. According

to Slocum, 'the failure of the enemy to gain possession of our works' was due 'entirely to the skill of General Greene and the heroic valor of his troops'. At daybreak on July 3, the weary brigade would again confront a serious assault.

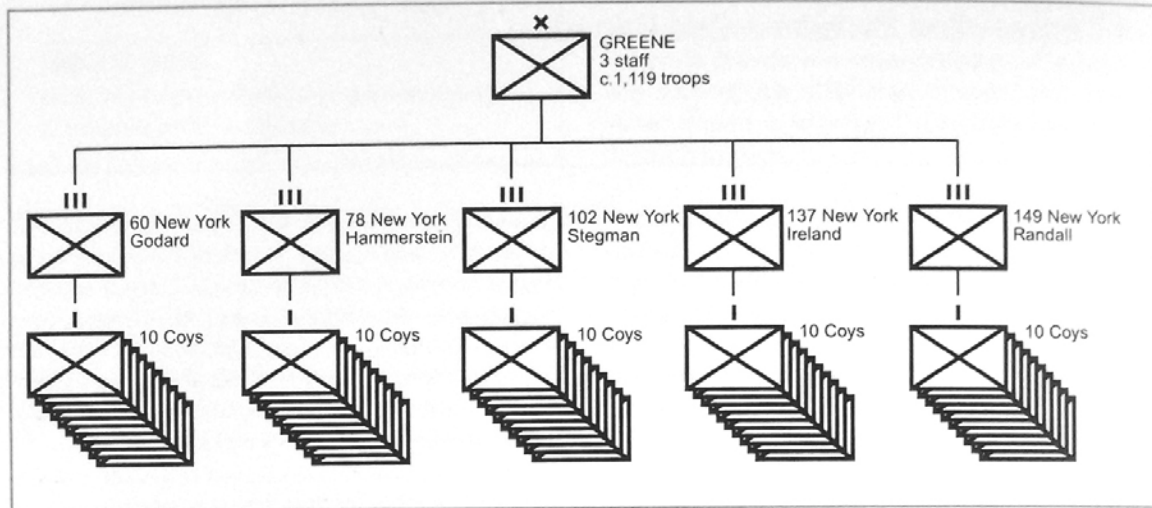

THIRD BRIGADE
Brigadier-General George Sears Greene

60th Regiment New York State Volunteers (Ogdenburgs Regiment) (Total casualties: 52)
 Colonel Abel Godard
 78th Regiment New York State Volunteers (78th Highlanders) (Total casualties: 30)
 Lieutenant-Colonel Herbert von Hammerstein
 102nd Regiment New York State Volunteers (Van Buren Light Infantry) (Total casualties: 29)
 Captain Lewis R. Stegman
 137th Regiment New York State Volunteers (Total casualties: 137)
 Colonel David Ireland
 149th Regiment New York State Volunteers (4th Onondaga Regiment) (Total casualties: 55)
 Lieutenant-Colonel Charles B. Randall

60th Regiment New York State Volunteers
 Colonel Godard
 Cos. A through K.
78th Regiment New York State Volunteers
 Lieutenant-Colonel von Hammerstein
 Cos. A through K.
102nd Regiment New York State Volunteers
 Captain Stegman
 Cos. A through K.
137th Regiment New York State Volunteers
 Colonel Ireland
 Cos. A through K.
149th Regiment New York State Volunteers
 Lieutenant-Colonel Randall
 Cos. A through K.

General Williams intended the artillery to play a dominant role by opening a tremendous bombardment, at daybreak, on July 3. They were to 'shell hell out of them'. Two units were already in position during

daylight on July 2. Winegar's Battery had one section on McAllister's Hill and one on Powers' Hill. Here it joined Knap's Battery. The other two batteries moved from their park along the Baltimore Pike during the night to take a position on a rise just west of the pike, 300 yards southeast of the Spangler buildings.

XII CORPS ARTILLERY BRIGADE
Lieutenant Edward D. Muhlenberg

Battery M, 1st New York Light Artillery
 Lieutenant Charles E. Winegar
 (90 troops present for duty equipped)
 (Total casualties: 0)
 4 x 10-pounder Parrott rifled guns

Battery E, Knap's Pennsylvania Light Artillery
 Lieutenant Charles A. Atwell
 (139 troops present for duty equipped)
 (Total wounded: 3)
 6 x 10-pounder Parrott rifled guns

Battery F, 4th United States Artillery
 Lieutenant Sylvanus Tunning Rugg
 (89 troops present for duty equipped)
 (Total wounded: 1)
 6 x 12-pounder Napoleon guns

Battery K, 5th United States Artillery
 Lieutenant David H. Kinzie
 (72 troops present for duty equipped)
 (Total wounded: 5)
 4 x 12-pounder Napoleon guns

THE ARMY OF THE POTOMAC XII CORPS' BATTLES

Geary's and Ruger's Divisions

Johnson Repulsed – 0430–1100 hrs

General Williams personally issued the order to the corps chief of artillery, Lieutenant Muhlenberg, to open fire at daybreak. A short but intense bombardment from XII Corps batteries, joined by Rigby's Battery from the artillery reserve, ensued. Once the 26 guns completed the bombardment, the Union infantry were supposed to charge. Instead came a Confederate assault.

The first attack followed the lines of assault from the previous evening. Again, as they had the previous

evening, Greene's men defended their breastworks stoutly. Assisting them was the 66th Ohio, which advanced to occupy a position at right angles to Greene's line. From this position the 66th poured enfilade fire into the enemy.

A second attack came against Greene's centre and right. Three of Candy's regiments, which were in reserve behind Greene's line, moved from the shelter of a ravine to replace the front-line units when they ran out of ammunition. Once they had fired off their own

With all its units returned overnight to the Culp's Hill area, XII Corps tried to deliver an attack, supported by an artillery bombardment, at daybreak on July 3. The timing of Johnson's own initial assault, planned for the same time, was thrown out by the pre-emptive Union attack. For more than six hours, the Corps fought successfully to hold its positions against two further rebel attacks.

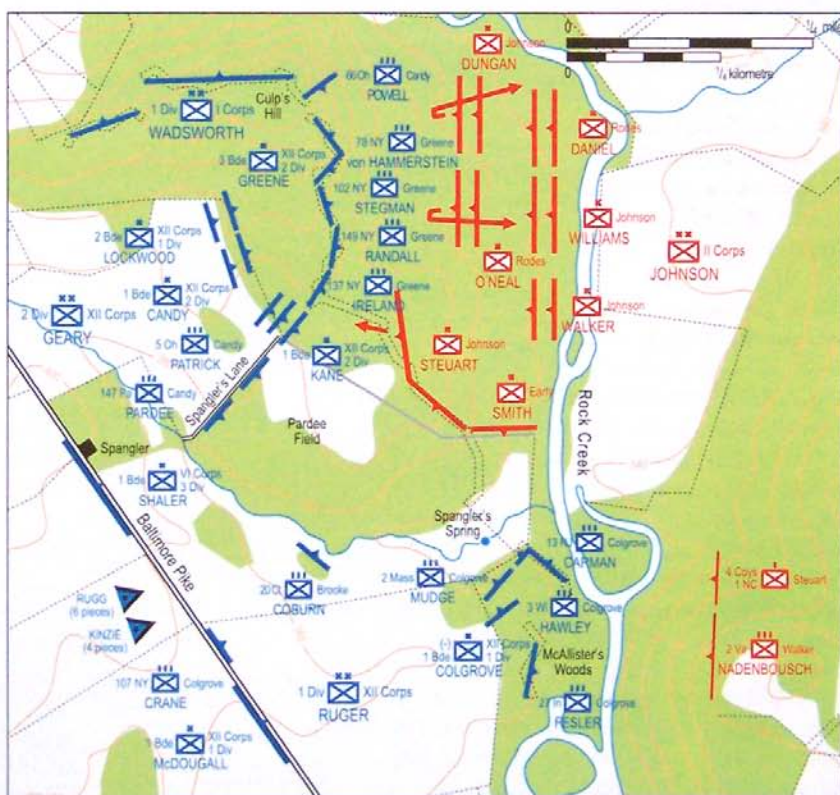

0400 hrs	0500	0600	0800	1000	1200	1300	1400	1500	1600	1700	1800
pages 75-76				35-4 & 91-95				17-19		90	

ammunition, Greene's men, who had renewed their supply, returned. Thus the defenders kept relatively fresh forces constantly in the front line. At any one time only about one-third of the defenders manned the breastworks. The defenders on the main summit of Culp's Hill were never in serious trouble.

A third and final attack came from the lower summit of the hill. It was directed against Geary's right. Simultaneously, the rebels made another charge against Greene's centre and right. Here too the defenders had ample reinforcements at hand to resist



Above: Once XII Corps had re-occupied Culp's Hill in strength, there was little likelihood that the Union infantry would fail to hold its positions. (Author's collection)

Right: The natural strength of XII Corps' position made it virtually unassailable. In addition, when Greene's front-line regiments ran low on ammunition, reserves from Candy's and Lockwood's Brigades were shuttled back and forth into the firing line atop Culp's Hill.

these attacks. Kane's Brigade and units belonging to Candy's Brigade defeated the Confederate efforts to advance across the Pardee Field. Even Shaler's Brigade from VI Corps put in a brief appearance. Although the Confederates attacked gallantly, the issue was never in doubt.

After the last attack failed, Colgrove received orders to attack the rebel left flank. To do this, his men had to charge across an open meadow at Spangler's Spring. When the commander of the 2nd Massachusetts received this order, he said, 'It is murder.' So it proved. Along with the 27th Indiana, the Massachusetts regiment advanced north from McAllister's Woods. The Confederates easily repulsed them.

XII Corps' Casualties at Gettysburg July 3 1863

Infantry killed or wounded 795
 Infantry missing/captured 42
 Artillery killed or wounded 1
 Artillery missing/captured 0

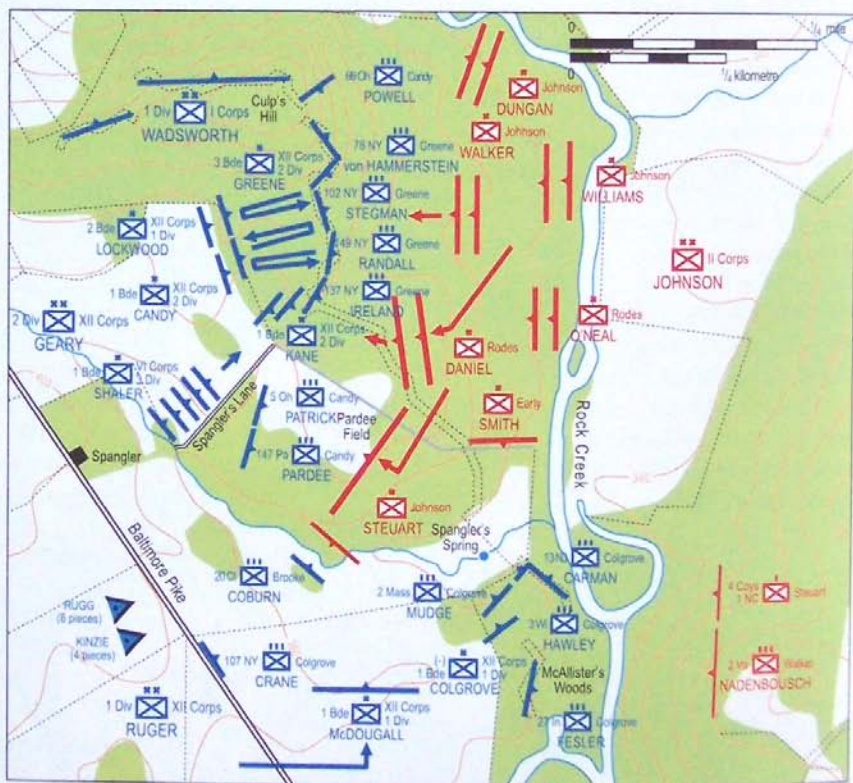

[Red bar]											
0400 hrs	0500	0600	0800	1000	1200	1300	1400	1500	1600	1700	1800
pages 75-76					35-4 & 91-95		17-19		90		

THE ARTILLERY RESERVE

Through the night the army's artillery officers worked hard to repair damage, replenish ammunition chests, reorganise, and replace battered units with fresh batteries from the Artillery Reserve. By daylight, 12 reserve batteries were in the line.

Rigby's Battery A, Maryland Light Artillery, contributed to the daybreak bombardment of the Confederate left. Taft's 5th New York Independent Battery maintained the same position on Cemetery Hill that it had held on July 2. Two sections on the west side of the Baltimore Pike faced northeast towards Benner's Hill and one section on the other side of the pike faced west. Mason's Battery H, 1st U.S., and Norton's Battery H, 1st Ohio, were in position just behind the Evergreen Cemetery. From this location they could sweep the ground across which Pettigrew's men would have to charge.

The reserve figured prominently in the action on

The Confederate artillery bombardment of the Union centre caught the commander of the Federal Artillery Reserve, Brigadier-General Robert Ogden Tyler, returning to the Union artillery park. Tyler's horse was shot out from under him, but he survived the fall. (USAMHI, Carlisle)



ARTILLERY RESERVE HEADQUARTERS

PROVOST GUARD

Co. C, 32nd Regiment Massachusetts Volunteer Infantry
Captain Josiah C. Fuller
(45 troops present for duty equipped)

AMMUNITION TRAIN GUARD

Cos. B, D, E, F, G, I & K
4th New Jersey Volunteer Infantry Regiment
Major Charles Ewing
(273 troops present for duty equipped)

THE ARTILLERY RESERVE Brigadier-General Robert Ogden Tyler

46 Staff and Field Officers
11 Ordnance Detachment

FIRST REGULAR BRIGADE

Captain Dunbar R. Ransom
2 Staff and Field Officers

Battery H, 1st United States Artillery

Lieutenant Chandler Price Eakin/
Lieutenant Philip D. Mason
(129 troops present for duty equipped)
6 x 12-pounder Napoleon guns

Batteries F & K, 3rd United States Artillery

Lieutenant John Graham Turnbull
(115 troops present for duty equipped)
6 x 12-pounder Napoleon guns

Battery C, 4th United States Artillery

Lieutenant Evan Thomas
(95 troops present for duty equipped)
6 x 12-pounder Napoleon guns

Battery C, 5th United States Artillery

Lieutenant Gulan Verplanck Weir
(104 troops present for duty equipped)
6 x 12-pounder Napoleon guns

July 3. Along Cemetery Ridge stood Ames' Battery G, 1st New York; Dow's Battery F, 6th Maine; Sterling's 2nd Battery, Connecticut Light Artillery; Hart's 15th New York; Phillips' 5th Battery, Massachusetts Light Artillery; and Thompson's Batteries C & F, Pennsylvania Light Artillery. When the rebel artillery bombardment began, Fitzhugh's Battery K, 1st New York Artillery, and Parson's Battery A, 1st New Jersey, moved to support the Federal line on Cemetery Ridge.

Because many corps artillery trains were well to the rear, numerous batteries drew upon the wagons of the Artillery Reserve. Referring to the great artillery duel preceding Pickett's Charge, General Hunt reported, 'In this emergency, the train of the Artillery Reserve, as on so many other occasions, supplied all demands, and proved its great usefulness.'

Every gun in the reserve entered combat at Gettysburg. During its two days of fighting, the Artillery

FIRST VOLUNTEER BRIGADE

Lieutenant-Colonel Freeman McGilvery
2 Staff and Field Officers

5th Battery, Massachusetts Light Artillery
(10th New York Battery attached)

Captain Charles Appleton Phillips
(104 troops present for duty equipped)
6 x 3-inch rifled guns

9th Battery, Massachusetts Light Artillery

Captain John Bigelow/
Lieutenant Richard Sweet Milton
(104 troops present for duty equipped)
6 x 12-pounder Napoleon guns

15th Battery, New York Light Artillery

Captain Patrick Hart
(70 troops present for duty equipped)
4 x 12-pounder Napoleon guns

Batteries C & F, Pennsylvania Independent Light Artillery

Captain James Thompson
(105 troops present for duty equipped)
6 x 3-inch rifled guns

SECOND VOLUNTEER BRIGADE

Captain Elijah D. Taft
2 Staff and Field Officers

Battery B, 1st Connecticut Heavy Artillery

Captain Albert F. Brooker
(110 troops present for duty equipped)
6 x 4.5-inch rifled guns

Battery M, 1st Connecticut Heavy Artillery

Captain Franklin A. Pratt
(110 troops present for duty equipped)
4 x 4.5-inch rifled guns - At Westminster and not engaged

2nd Battery, Connecticut Light Artillery

Captain John William Sterling
(93 troops present for duty equipped)
4 x James rifled guns
1 x 12-pounder howitzer

5th Battery, New York Light Artillery

Captain Elijah D. Taft
(146 troops present for duty equipped)
6 x 20-pounder Parrott rifled guns

THIRD VOLUNTEER BRIGADE

Captain James F. Huntington
2 Staff and Field Officers

1st Battery, New Hampshire Light Artillery

Captain Frederick Mason Edgell
(86 troops present for duty equipped)
4 x 3-inch rifled guns

Battery H., 1st Ohio Light Artillery

Lieutenant George W. Norton
(99 troops present for duty equipped)
6 x 3-inch rifled guns

Batteries F & G, 1st Pennsylvania Light Artillery

Captain Robert Bruce Ricketts
(144 troops present for duty equipped)
6 x 3-inch rifled guns

Battery C, West Virginia Light Artillery

Captain Wallace Hill
(100 troops present for duty equipped)
4 x 10-pounder Parrott rifled guns

FOURTH VOLUNTEER BRIGADE

Captain Robert Hughes Fitzhugh
2 Staff and Field Officers

Battery F, 6th Maine Light Artillery

Lieutenant Edwin Barlow Dow
(87 troops present for duty equipped)
4 x 12-pounder Napoleon guns

Battery A, Maryland Light Artillery

Captain James H. Rigby
(106 troops present for duty equipped)
6 x 3-inch rifled guns

1st Battery, New Jersey Light Artillery

Lieutenant Augustin N. Parsons
(98 troops present for duty equipped)
6 x 10-pounder Parrott rifled guns

Battery G, 1st New York Light Artillery

Captain Nelson Ames
(84 troops present for duty equipped)
6 x 12-pounder Napoleon guns

Battery K, 1st New York Light Artillery

Captain Robert Hughes Fitzhugh
(122 troops present for duty equipped)
6 x 3-inch rifled guns

316 horses lost.

General Hunt proudly reported, 'It will be seen that the Artillery Reserve ... bore, as in all the campaigns of the Army of the Potomac, its full share, and more, of the losses.'

Reserve had two officers and 41 men killed, 15 officers and 171 men wounded, 15 missing. There were also

THE ARMY OF THE POTOMAC

THE CAVALRY CORPS



On the evening of July 2, army commander Meade held his celebrated council of war with his senior commanders. The fact that the commander of the Cavalry Corps, Major-General Alfred Pleasonton, did not participate in the voting to decide strategy is indicative of the cavalry's subordinate role in Meade's plan. Meade expected the next Confederate blow to strike his centre. He gave Pleasonton the assignment of keeping his flanks secure.

On July 3 the Federal cavalry corps had largely recovered from its previous dispersal. An exception was Buford's Division, which Pleasonton allowed to move off to Westminster, some 30 miles away, for rest and refit at the railhead supply base. Only Merritt's Reserve Brigade, which had not fought in the division's July 1 battles, remained within recall distance. Merritt received orders at around noon on July 3 to move from Emmitsburg, some 10 miles away, to support Kilpatrick on the army's left flank.

Pleasanton assigned the 2nd Division the task of guarding the right flank. During July 2, elements of the 2nd Division had occupied some of the ground around Brinkerhoff's Ridge. Here McIntosh's Brigade had skirmished with Walker's Stonewall Brigade. By occupying the attention of a full Confederate brigade, the cavalry had reduced the number of enemy available for the nocturnal assaults against Culp's Hill. On July 3, Gregg's two brigades were to stretch from

Major-General Alfred Pleasonton would himself play no role in the events of July 3. He performed poorly at Gettysburg. By failing to provide General Meade with accurate intelligence, he did not fulfil the cavalry's primary role of reconnaissance. (USAMHI, Carlisle)



CAVALRY CORPS HEADQUARTERS

ESCORT

Co. 1, 1st Maine Cavalry Regiment

Captain Constantine Taylor

(30 troops present for duty equipped)

CAVALRY CORPS

Major-General Alfred A. Pleasonton

27 Staff and Field Officers

First Division

Brigadier-General John Buford

Second Division

Brigadier-General David McMurtree Gregg

Third Division

Brigadier-General Hugh Judson Kilpatrick

Cavalry Corps Horse Artillery – 1st Brigade

Captain James M. Robertson

Cavalry Corps Horse Artillery – 2nd Brigade

Captain John C. Tidball

Wolf's Hill to the intersection of the Low Dutch Road and the Hanover Road. Custer's Brigade, belonging to the 3rd Division, was also at this intersection. Once Brigadier-General David Gregg's 2nd Division relieved it, it had orders to move to the army's opposite flank. Pleasanton assigned Brigadier-General Judson Kilpatrick the duty of guarding the army's left flank. Pleasanton expected this aggressive commander to take advantage of any opportunity that presented itself on this flank.

Although, compared to past operations, the Union cavalry corps was better able to mass its strength during the summer of 1863, a number of units continued to be drained in order to provide ancillary functions. Meade's own headquarters force included the Oneida Cavalry for use as orderlies and couriers and an escort comprising Regulars detached from various regiments in Merritt's Brigade and portions of the 1st, 2nd and 6th Pennsylvania Cavalry. When Meade's headquarters became an unintended target of the great Confederate bombardment, the squadron of the 6th Pennsylvania lost 21 horses killed, with most of the rest wounded.

A number of cavalry detachments also operated away from the main battlefield. Troopers of Huey's

THE CAVALRY CORPS – GETTYSBURG – July 3

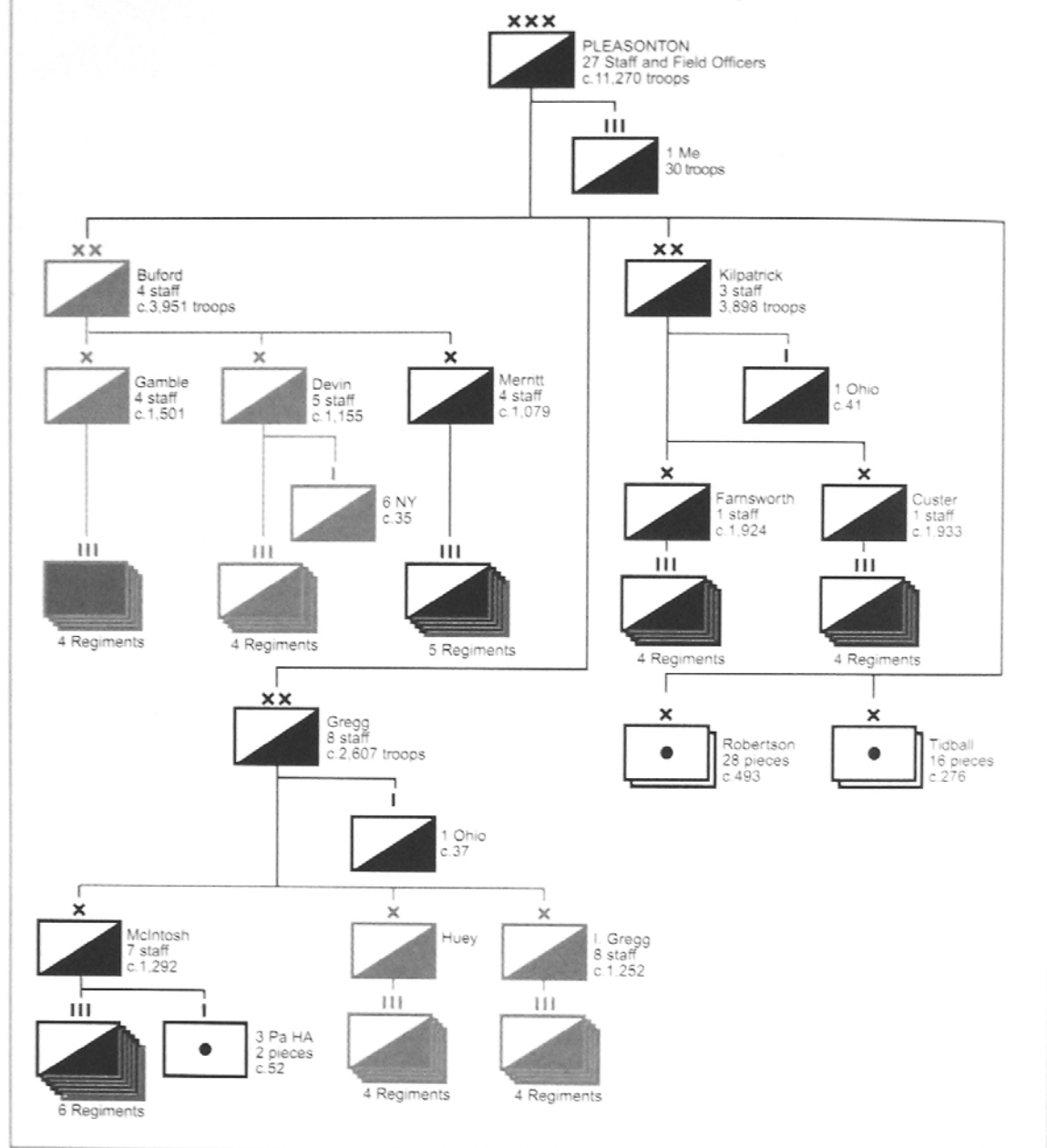

Brigade guarded a supply depot at Manchester. It frustrated one young soldier, who wrote, 'The firing is getting heavier all the time. I almost wish they would send us there, for I hate to hear a battle going on and not partake of its dangers.'

While moving to its assigned position on the Union left flank, a civilian told Merritt that a rebel forage train was passing through Fairfield, some eight miles away. Merritt chose to send four squadrons of his largest

regiment, the 6th U.S., under the command of Major Starr, to capture it. Starr unwisely divided his force in an effort to trap the train. Then one prong unexpectedly encountered opposition from Virginia cavalry. Starr had stirred up Grumble Jones' entire brigade. The Confederates counter-attacked vigorously compelling Starr to commit his own column in a sacrificial charge. By the time the combat ended, the regulars had lost 242 casualties.

Cavalry Corps – 1st Division

July 2 had seen Brigadier-General John Buford's 1st Division operating on the Union left, some three-quarters of a mile west of Little Round Top. From dawn until well past noon, dismounted troopers skirmished with rebel infantry along the Emmitsburg Road.

Although the division had suffered about a five percent loss rate on July 1, it remained an effective fighting force. Thus, it is surprising that its heretofore

1st DIVISION

Brigadier-General John Buford

(first two brigades to divisional trains – not engaged on July 3)

FIRST BRIGADE

Colonel William Gamble

8th Cavalry Regiment Illinois Volunteers

(Total casualties: 7)

Major John Lourie Beveridge

12th Cavalry Regiment Illinois Volunteers

(Total casualties: 20)

Colonel George Henry Chapman

3rd Regiment Indiana Cavalry (45th Volunteers)

(Total casualties: 32)

Colonel George Henry Chapman

8th New York Volunteer Cavalry Regiment

(Total casualties: 40)

Lieutenant-Colonel William Lester Markell

SECOND BRIGADE

Colonel Thomas C. Devin

Escort

Co. L, 6th New York Cavalry Regiment

Captain William Thompson

(35 troops present for duty equipped)

6th New York Volunteer Cavalry Regiment

(Total casualties: 9)

Major William Elliott Beardsley

9th New York Volunteer Cavalry Regiment

(Total casualties: 11)

Colonel William Sackett

17th Regiment Pennsylvania Cavalry (162nd Volunteers)

(Total missing/captured: 4)

Colonel Josiah Holcomb Kellogg

3rd Regiment West Virginia Cavalry

(Total missing/captured: 4)

Captain Seymour Beach Conger

RESERVE BRIGADE

Brigadier-General Wesley Merritt

DIVISIONAL HEADQUARTERS

ESCORT

Co. I, 1st Maine Cavalry Regiment

Lieutenant-Colonel Charles Henry Smith

(30 troops present for duty equipped)

Brigadier-General John Buford's inexplicable departure from the battle on its second day gives rise to the speculation that he was already suffering from the illness that would lead to his death late in 1863. (USAMHI, Carlisle)



FIRST DIVISION

Brigadier-General John Buford

1st Brigade – c.1,501 troops

2nd Brigade – c.1,155 troops

Reserve Brigade – c.1,079 troops

highly aggressive commander should have asked Pleasonton for permission to depart the field. Buford wanted to rest and refit the two brigades that had fought on July 1 and judged that he could not do this unless he had access to the divisional trains. Equally curious is the fact that Pleasonton assented.

At about 0900 hrs Gamble's Brigade rode off. A few hours later Devin's Brigade followed. Only one squadron of the 9th New York Cavalry remained to screen the flank of Sickles' III Corps. The commander of Battery A, 2nd U.S. Artillery, Lieutenant John Calef, spoke for most of the command in wondering why they were turning their backs to the sound of the guns: 'Notwithstanding the severe work of the 1st, every one showed himself ready for a continuation on the morning of the 2d.'

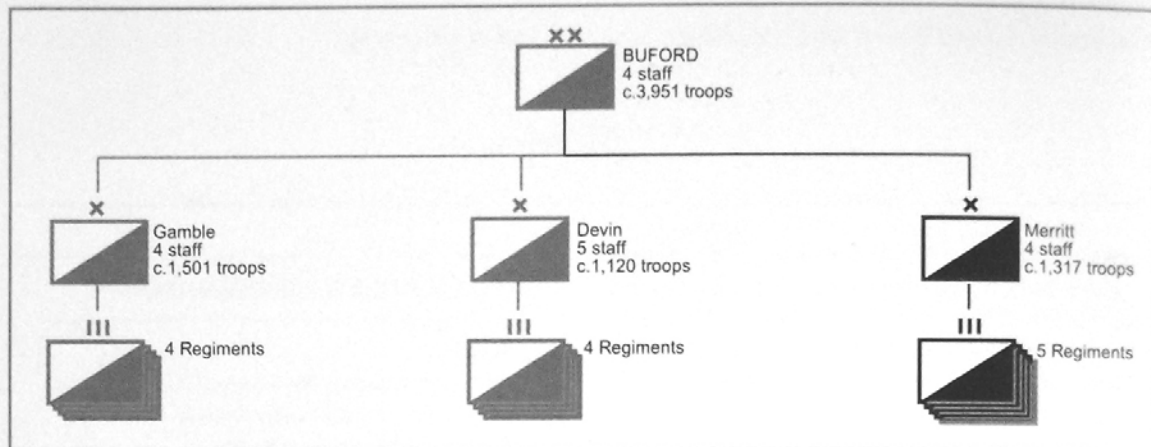

Cavalry Corps – 1st Division – Reserve Brigade

Brigadier-General Wesley Merritt's Reserve Brigade had not participated in the division's epic stand on July 1. It had been performing scouting and guard duty in the army's left rear around Mechanicsburg, Maryland, about 18 miles southwest

Brigadier-General Wesley Merritt, 29, attended West Point, and served with the 2nd Dragoons in Utah. After an error-ridden sojourn at Gettysburg, he excelled at his work and eventually rose to command the Cavalry Corps. (U.S. National Archives)

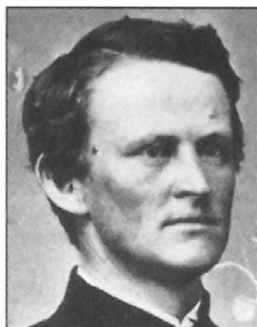

of Gettysburg. On July 2 it moved to Emmitsburg, 10 miles south of the action. Finally, at around noon of July 3, the brigade received orders to join General Judson Kilpatrick as that officer probed the Confederate right flank. During the march, Merritt detached four squadrons of the 6th U.S. on its ill-fated mission to Fairfield. The rest of the brigade reached the field at about 1500 hrs.

Operating under the direction of Kilpatrick, the brigade deployed just east of the Emmitsburg Pike, about 300 yards west of Farnsworth's Brigade. Here, unlike the terrain confronting Farnsworth, the ground was relatively open. After some 90 minutes of

RESERVE BRIGADE Brigadier-General Wesley Merritt

6th Pennsylvania Cavalry Regiment (70th Volunteers)
(Total casualties: 12)
Major James Henry Haseltine
1st United States Cavalry Regiment
(Total casualties: 15)
Captain Richard S.C. Lord
2nd United States Cavalry Regiment
(Total casualties: 17)
Captain Theophilus Francis Rodenbough
5th United States Cavalry Regiment
(Total casualties: 5)
Captain Julius Wilmot Mason
6th United States Cavalry Regiment
(not at Gettysburg)
Major Samuel H. Starr

ineffectual skirmishing, Merritt advanced up the pike at about 1630 hrs. Covered by the fire of Captain William Graham's 3-inch rifles, the troopers advanced and drove pickets belonging to the 9th Georgia from the Kern house and its outbuildings. A mounted charge by the 5th U.S. followed up this success. However, additional Confederate units shifted to oppose Merritt and to prevent the troopers from gaining a significant lodgement. Merritt observed the action and decided that he should dismount his command. This decision negated any advantage the cavalry had versus Confederate infantry. In addition, the rebels received fire support from two batteries. The combined infantry

and artillery fire stopped Merritt's advance. Then, more Confederates descended from the slope of Big Round Top to assail Merritt's right flank. The attack rolled up the Union line and sent the troopers back to their start line. During this action the brigade lost about 50 men. By 1700 hrs, Merritt's effort ended. Later Farnsworth would conduct his death charge across broken terrain to the brigade's right. Thus, Farnsworth, like Merritt, would confront the undivided attention of the enemy. Kilpatrick had notably failed to co-ordinate the two brigades. Despite Merritt's disappointing debut as a brigadier-general, he replaced Buford after that officer's illness and death later in the year.

6th Pennsylvania Cavalry Regiment (70th Volunteers)

Major Haseltine
Cos. A through D, F through H & K through M.

1st United States Cavalry Regiment

Captain Lord
Cos. A through E, G through I & L and M.

2nd United States Cavalry Regiment

Captain Rodenbough
Cos. A through M.

5th United States Cavalry Regiment

Captain Mason
Cos. A through M.

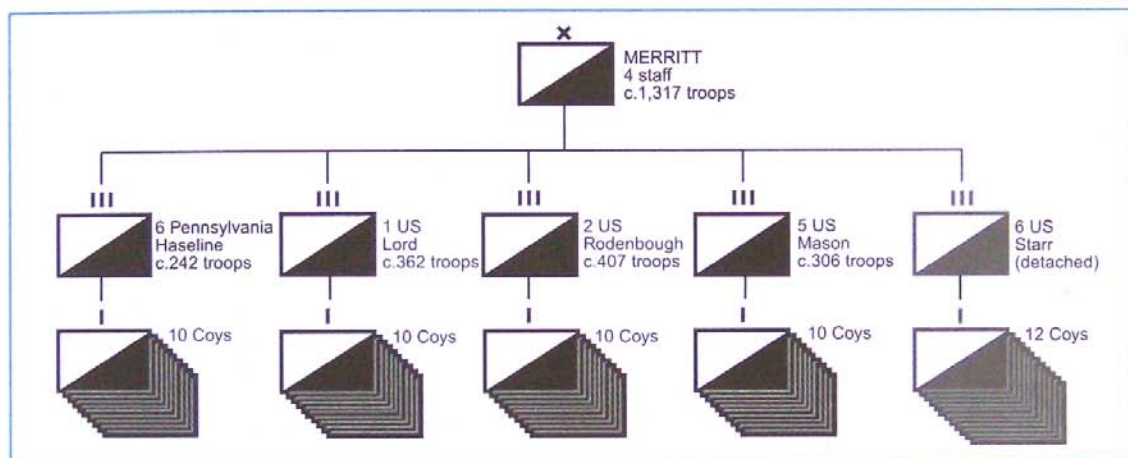

Cavalry Corps – 2nd Division

Brigadier-General David Gregg's division, which took the field at Gettysburg, comprised two brigades with nine regiments, an independent company known as the Purnell Legion and an attached artillery section. These latter two formations had joined the division by chance. Captain William Rank's section had been guarding the railroad bridge over the Monocacy River at Frederick when the

The modest and capable Brigadier-General David McMurtre Gregg was an unsung hero on July 3 at Gettysburg. Despite this lack of recognition at the time, he went on to command the Cavalry Corps on three occasions in 1864. Gregg then reverted to divisional command until he resigned in 1865. He retired to farm in his native Pennsylvania. (USAMHI, Carlisle)



SECOND DIVISION

Brigadier-General David McMurtre Gregg

1st Brigade – c.1,292 troops

2nd Brigade – detached

3rd Brigade – c.1,252 troops

2nd DIVISION

Brigadier-General David McMurtrie Gregg

FIRST BRIGADE

Colonel John B. McIntosh

SECOND BRIGADE

(Brigade at Westminster – not present at Gettysburg)

Colonel Pennock Huey

- 2nd New York Volunteer Cavalry Regiment
- Lieutenant-Colonel Otto Harhaus
- 4th New York Volunteer Cavalry Regiment
- Lieutenant-Colonel Augustus Pruyn
- 6th Regiment Ohio Volunteer Cavalry
- Major William Stedman
- 8th Regiment Pennsylvania Cavalry (89th Volunteers)
- Captain William A. Corrie

THIRD BRIGADE

Colonel J. Irvin Gregg

- 1st Maine Cavalry Regiment
- (Total casualties: 5)
- Lieutenant-Colonel Charles Henry Smith
- 10th New York Volunteer Cavalry Regiment
- (Total casualties: 9)
- Major Mathew Henry Avery
- 4th Regiment Pennsylvania Cavalry (64th Volunteers)
- (Total killed: 1)
- Lieutenant-Colonel William Emile Doster
- 16th Regiment Pennsylvania Cavalry (161st Volunteers)
- (Total casualties: 6)
- Lieutenant-Colonel John Kincaid Robison

DIVISIONAL HEADQUARTERS

ESCORT

Co. A, 1st Regiment Ohio Volunteer Cavalry

Captain Noah Jones

37 troops present for duty equipped

of the Low Dutch Road and Hanover Road, about three and a half miles east of Gettysburg. Here, protected by an advanced infantry skirmish line of the 9th Massachusetts, the troopers dismounted to allow their horses to graze. It was a welcome rest. The trials and tribulations endured over the past weeks had depleted men and horses alike. The 3rd Pennsylvania, for example, had 384 men but only 322 serviceable horses. When General David Gregg learned that the infantrymen were assigned to another sector, he ordered his cousin, Irvin Gregg, to replace them with the 10th New York Cavalry. The New Yorkers went into position astride the Hanover Road. Mindful of his assignment to cover Meade's right flank, Gregg had the 16th Pennsylvania extend the picket line to the left all the way to the slopes of Wolf Hill. Further to the rear, McIntosh posted a section of Captain Rank's battery on some high ground.

The 10th New York skirmished during the afternoon until the 2nd Virginia aggressively moved down from Brinkerhoff's Ridge at about 1800 hrs. Even though they were armed with Spencer repeaters, the New Yorkers failed to offer much resistance. They retired hastily, losing two killed, four wounded, and three captured. The retreat cleared the field for Rank's two 3-inch rifles, which now fired their first shots of the war in anger. Gregg ordered McIntosh to advance to stem the rebel advance. A brief struggle over a contested fence line ensued and the rebels retired.

Confederates marched north. Ordered back to Annapolis, the section had marched with Company A of the Purnell Legion through Cooksville, Maryland. Here they had almost been captured by Stuart's cavalry. The following day they encountered McIntosh's Brigade and resolved to remain with that formation.

July 2 found the division moving to the intersection

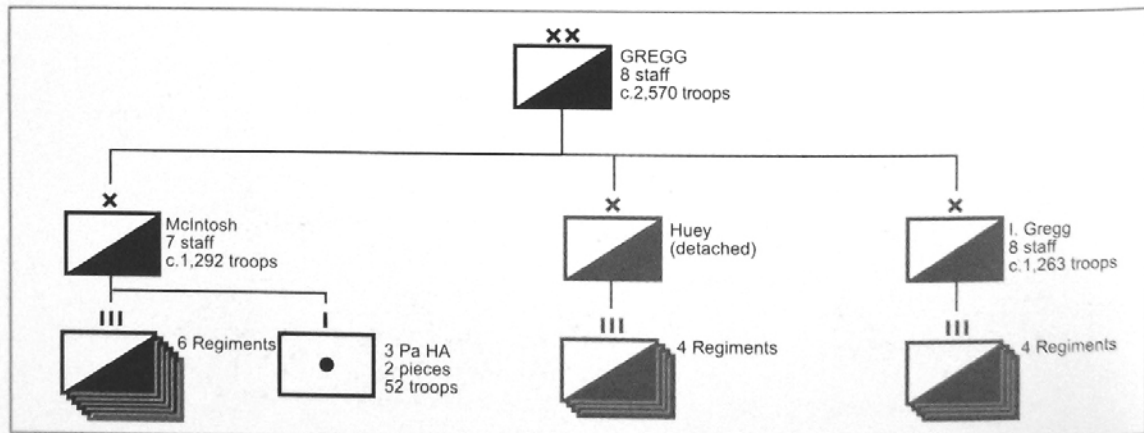

Cavalry Corps – 2nd Division – 1st Brigade

When the Cavalry Corps came into being in February 1863, Colonel John McIntosh received a brigade in Averill's Division. The

Colonel John Baillie McIntosh was the son of an officer killed in the Mexican War. He was a 'born fighter, a strict disciplinarian, a dashing leader, and a polished gentleman'.

(U.S. National Archives)



brigade fought well at Kelly's Ford in March but did not participate in the Chancellorsville Campaign. When Hooker sacked Averill, McIntosh maintained his

Congressional Medal of Honor

Name: William E. Miller

Rank: Captain

Unit: Co. H, 3rd Regiment Pennsylvania Cavalry

Date: July 3 1863

Citation: Without orders, led a charge of his squadron upon the flank of the enemy, checked his attack, and cut off and dispersed the rear of his column.

FIRST BRIGADE

Colonel John B. McIntosh

- 1st Maryland Regiment of Cavalry
(Total casualties: 3)
- Lieutenant-Colonel James Monroe Deems
1st Regiment Massachusetts Volunteer Cavalry
(detached to right flank)
(Total casualties: unknown)
- Lieutenant-Colonel Greely Stevenson Curtis
Purnell Legion (Maryland)
(Total casualties: 0)
- Captain Robert Emmet Duvall
1st New Jersey Regiment of Cavalry (16th Volunteers)
(Total wounded: 9)
- Major Myron Holley Beaumont
1st Regiment Pennsylvania Cavalry (44th Volunteers)
(Total missing/captured: 2)
- Colonel John P. Taylor
3rd Regiment Pennsylvania Cavalry (60th Volunteers)
(Total casualties: 21)
- Lieutenant-Colonel Edward S. Jones
3rd Pennsylvania Heavy Artillery (152nd Volunteers)
(Total casualties: 0)
- Captain William D. Rank
Section with 2 x 3-inch rifled guns

friendship with the now discredited general. This, coupled with his Florida birth and his conservative democratic politics, probably caused his demotion to

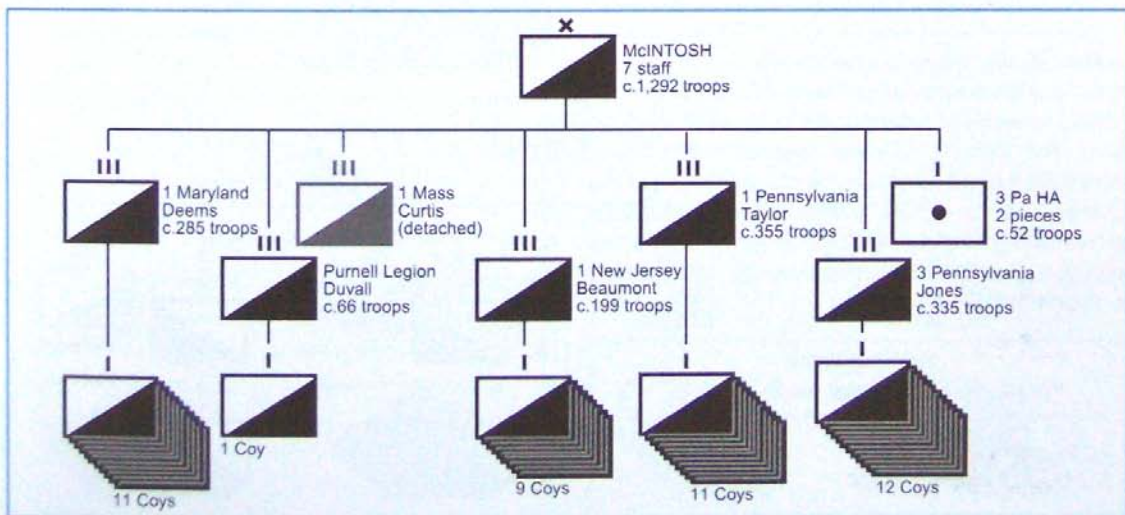

regimental command. However, when the brigade leader, Colonel Percy Wyndham, received a wound at Brandy Station, McIntosh returned to brigade command. Thus, he had a mere three weeks to familiarise himself with his command before Gettysburg.

After daybreak on July 2, the brigade entered Hanover, the recent scene of a fight between Stuart and Kilpatrick. After a rest, it moved to the intersection of the Low Dutch Road and the Hanover Road, about three and a half miles east of Gettysburg. At 1900 hrs, two squadrons of the 3rd Pennsylvania, two squadrons of the 1st New Jersey and the Purnell Legion moved west along the Hanover Road to relieve the 10th New York, which had been skirmishing with units of the Stonewall Brigade. A brief struggle ensued in which the 3rd Pennsylvania lost one wounded and three captured. Dusk put an end to the fighting.

Cavalry Corps – 3rd Division

1st Maryland Regiment of Cavalry

Lieutenant-Colonel Deems

Cos. A through L.

Purnell Legion (Maryland)

Captain Duvall

Company A.

1st New Jersey Regiment of Cavalry (16th Volunteers)

Major Beaumont

Cos. A through D, F, H, I, K & M.

1st Regiment Pennsylvania Cavalry (44th Volunteers)

Colonel Taylor

Cos. A through G, I through M.

3rd Regiment Pennsylvania Cavalry (60th Volunteers)

Lieutenant-Colonel Jones

Cos. A through M.

3rd Pennsylvania Heavy Artillery (152nd Volunteers)

Captain Rank

1 Section

The 3rd Cavalry Division had a sharp skirmish with Stuart's troopers at Hanover, 15 miles east of Gettysburg, on June 30. After the rebels

DIVISIONAL HEADQUARTERS

ESCORT

Co. C, 1st Regiment Ohio Volunteer Cavalry

Captain Samuel N. Stanford

41 troops present for duty equipped



Brigadier-General Judson 'Kill Cavalry' Kilpatrick was a diminutive and highly aggressive man. A graduate of West Point, his typical cavalier's ambition and self-promotion led him to both dashing successes and foolhardy losses.

(USAMHI, Carlisle)

skilfully broke contact, the division spent July 1 searching the area between Hanover and East Berlin.

Having received orders on July 2 to rejoin the main army, the division marched towards Hunterstown. Here it skirmished with Hampton's men. That night the division withdrew to Two Taverns, five miles southeast of Gettysburg. At about 0800 hrs on July 3, the division marched towards the Emmitsburg Road, where it was to secure the army's left flank.

THIRD DIVISION

Brigadier-General Hugh Kilpatrick

1st Brigade – c.1,924 troops

2nd Brigade – c.1,933 troops

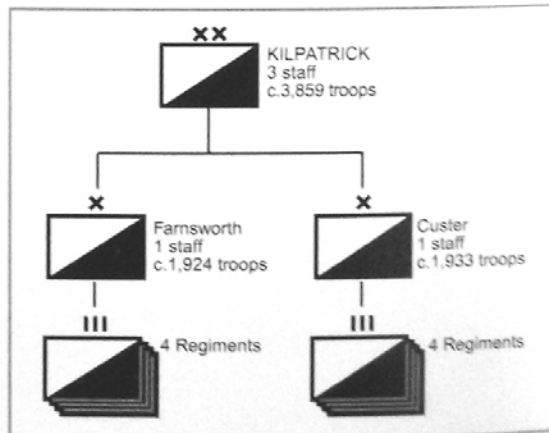

Cavalry Corps – 3rd Division – 1st Brigade

After spending July 1 on a futile search for Stuart's cavalry, the brigade moved to Hunterstown, five miles northeast of



Brigadier-General Elon John Farnsworth, 26, had been expelled from college for a disastrous prank that killed a fellow student. His appointment to the staff of his uncle's cavalry regiment launched him on a brief, but promising, wartime career. (USAMHI, Carlisle)

Gettysburg. The next day it participated on the fringes of Custer's fight against Hampton's Brigade, where it apparently spent most of its effort trying to locate and capture a reported Confederate wagon train. It then moved across the rear of the Union army to take station on the Union left.

Congressional Medal of Honor

Name: Williams Wells
Rank: Major
Unit: 1st Vermont Cavalry Regiment
Date: July 3 1863
Citation: Led the second battalion of his regiment in a daring charge.

FIRST BRIGADE

Brigadier-General Elon John Farnsworth/
 Successor unknown

5th New York Volunteer Cavalry Regiment
 (Total killed: 1)
 Major John Hammond
 18th Regiment Pennsylvania Cavalry (163rd Volunteers)
 (Total casualties: 14)
 Lieutenant-Colonel William Penn Brinton
 1st Vermont Cavalry Regiment
 (Total casualties: 65)
 Lieutenant-Colonel Addison Webster Preston
 1st Regiment West Virginia Cavalry
 (Total casualties: 12)
 Colonel Nathaniel Pendleton Richmond

5th New York Volunteer Cavalry Regiment

Major Hammond
 Cos. A through M.

18th Regiment Pennsylvania Cavalry (163rd Volunteers)

Lieutenant-Colonel Brinton
 Cos. A through M.

1st Vermont Cavalry Regiment

Lieutenant-Colonel Preston
 Cos. A through M.

1st Regiment West Virginia Cavalry

Colonel Richmond
 Cos. B through H, L, M & N.

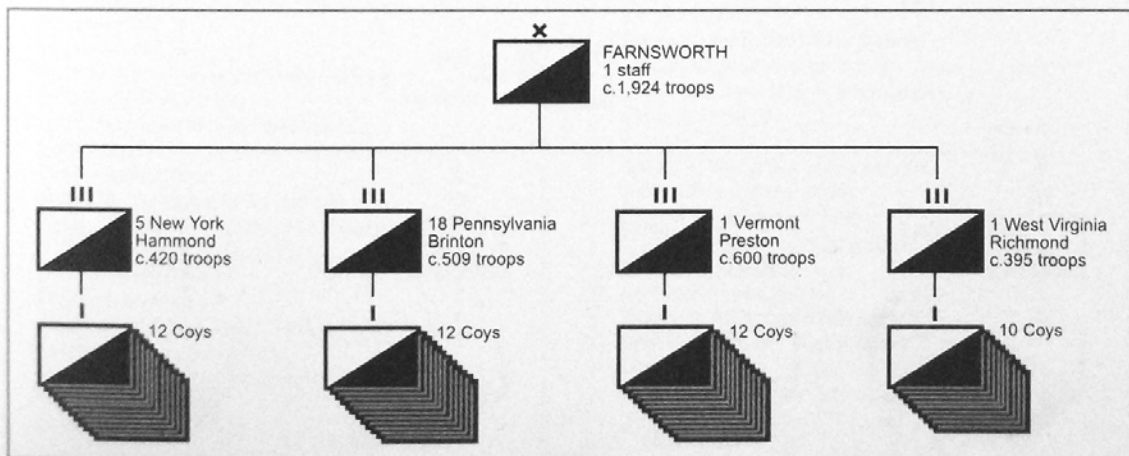

Cavalry Corps – 3rd Division – 2nd Brigade

The Michigan Brigade

The all-Michigan 2nd Brigade spent July 1 futilely searching for Stuart. It found Hampton's Brigade the next day in Hunterstown, five miles northwest

Brigadier-General George Armstrong Custer. He was last in his West Point class of 1861 and maintained the tradition of the flamboyant cavalier. He was scornfully described as looking 'like a circus rider gone mad'.

(U.S. National Archives)



SECOND BRIGADE (The Michigan Brigade)
Brigadier-General George Armstrong Custer

1st Regiment Michigan Cavalry

(Total casualties: 73)

Colonel Charles H. Town

5th Regiment Michigan Cavalry

(Total casualties: 56)

Colonel Russell Alexander Alger

6th Regiment Michigan Cavalry

(Total casualties: 28)

Colonel George Gray

7th Regiment Michigan Cavalry

(Total casualties: 100)

Colonel William D'Alton Mann

1st Regiment Michigan Cavalry

Colonel Town

Cos. A through M.

5th Regiment Michigan Cavalry

Colonel Alger

Cos. A through M.

6th Regiment Michigan Cavalry

Colonel Gray

Cos. A through M.

7th Regiment Michigan Cavalry

Colonel Mann

Cos. A through I & K.

of Gettysburg. Custer personally led a charge up a narrow road lined with enemy marksmen. So poorly prepared was the charge that the attackers also suffered from misdirected friendly fire. After suffering 32 losses, the cavalry recoiled. Custer had a horse shot out from under him. However, when Hampton tried to exploit his advantage, dismounted Union troopers, assisted by two horse artillery batteries, repulsed the rebels. That night the brigade moved to Two Taverns, five miles southeast of Gettysburg.

When the division moved off the next morning to guard the army's left flank, Brigadier-General David Gregg ordered the brigade out of line and into a position near the intersection of the Hanover Road and Low Dutch Road, initially facing west. From this location it would take part in the impending combat at Rummel's Farm.

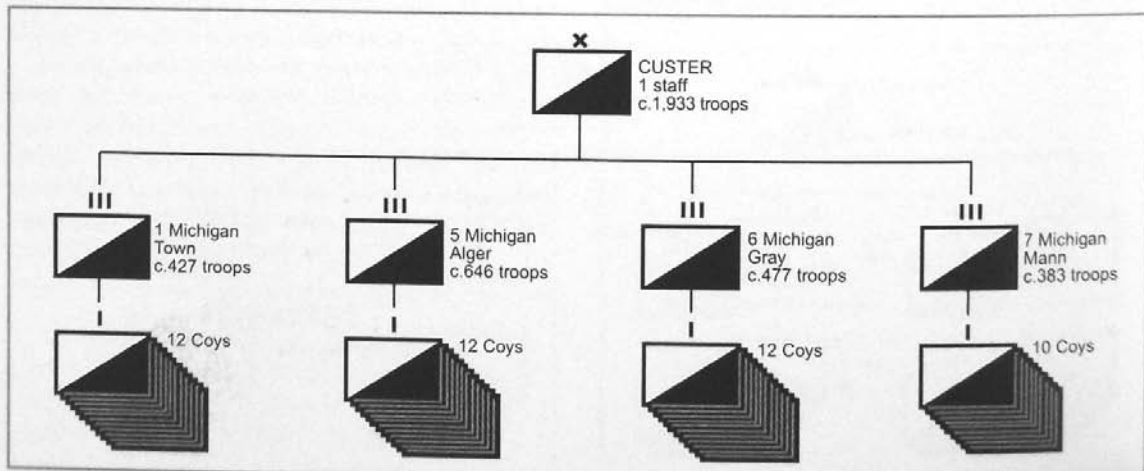

Cavalry Corps – 1st and 2nd Horse Artillery Brigades

If operating in mass, this organisation's nine horse artillery batteries provided mobile firepower superior to any other formations on the field. However, instead, the batteries were dispersed over a wide territory. Lieutenant William Fuller's Battery C, 3rd U.S., was with Huey's Brigade in Manchester guarding the rail depot. Lieutenant John Calef's Battery A, 2nd U.S., was resting, with Buford, at Westminster.

Two batteries belonging to the 1st Artillery Brigade, the 6th New York and Batteries B and L, 2nd U.S., were in reserve near Pleasonton's headquarters. Here they would endure the overshooting from the great rebel bombardment. Captain Jabez Daniels' 9th Michigan was in position along the right-centre of Meade's line where it supported the infantry of I Corps.

Only four horse artillery batteries were actually in position to support active cavalry operations. Those commanded by Captain Alanson Randol and Lieutenant Alexander Pennington, Jr. were on the Union right. Here they would provide important service

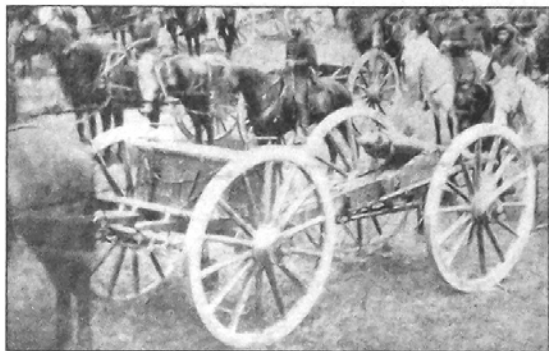

Mounted batteries from the 2nd and 3rd United States Artillery, part of the 2nd Brigade at Gettysburg. (MARS)

during the combat around Rummel's Farm. Captain William Graham's Battery K, 1st U.S., supported the ill-judged advance by Merritt's Brigade against the Confederate right. Nearby, Lieutenant Samuel Elder's Battery E, 4th U.S., tried to support the efforts of Farnsworth's Brigade as it struggled against rebel infantrymen on the slopes of Big Round Top.

FIRST HORSE ARTILLERY BRIGADE

Captain James M. Robertson

9th Michigan Battery

Captain Jabez J. Daniels
(111 troops present for duty equipped)
(Total casualties: 5)

6 x 3-inch rifled guns

6th New York Battery

Captain Joseph William Martin
(103 troops present for duty equipped)
(Total wounded: 1)

6 x 3-inch rifled guns

Batteries B & L, 2nd United States Artillery

Lieutenant Edward Heaton
(99 troops present for duty equipped)
(Total casualties: 0)

6 x 3-inch rifled guns

Battery M, 2nd United States Artillery

Lieutenant Alexander Cummings McWhorter Pennington, Jr.
(117 troops present for duty equipped)
(Total wounded: 1)

6 x 3-inch rifled guns

Battery E, 4th United States Artillery

Lieutenant Samuel Sherer Elder
(61 troops present for duty equipped)
(Total killed: 16)

4 x 3-inch rifled guns

SECOND HORSE ARTILLERY BRIGADE

Captain John C. Tidball

Batteries E & G, 1st United States Artillery

Captain Alanson Merwin Randol
(85 troops present for duty equipped)
(Total casualties: 0)

4 x 3-inch rifled guns

Battery K, 1st United States Artillery

Captain William Montrose Graham
(114 troops present for duty equipped)
(Total casualties: 3)

6 x 3-inch rifled guns

Battery A, 2nd United States Artillery

(with Buford at Westminster)
Lieutenant John Haskell Calef
(75 troops present for duty equipped)
(Total wounded: 12)

6 x 3-inch rifled guns

Battery C, 3rd United States Artillery

(with Huey's Cavalry Brigade at Manchester)
Lieutenant William D. Fuller
(142 troops present for duty equipped)

6 x 3-inch rifled guns

THE ARMY OF THE POTOMAC CAVALRY CORPS' BATTLES

Farnsworth's Brigade

'Kill Cavalry' Attacks the Confederate Right – 1700–1800 hrs

The action began when Kilpatrick ordered a squadron of the 1st Vermont Cavalry, commanded by Captain Henry Parsons, to probe the enemy position. Parsons' troopers charged for a half mile up a narrow lane. They drove through an infantry outpost and reached the Bushman house. At about 1700 hrs, Kilpatrick ordered the 1st West Virginia to charge what he supposed was a mere rebel skirmish line. Advancing without reconnaissance, the regiment encountered a fence. While troopers struggled to create a crossing, Texas infantry rushed up and fired several deadly volleys. The regiment retired in some disorder.

When Kilpatrick detected a shift in Confederate dispositions, he thought he saw an opening. He ordered Farnsworth to charge. Farnsworth was appalled. He said to a fellow officer, 'My God, Hammond, Kil is going to have a cavalry charge. It is too awful to think of.' The advance of the 18th Pennsylvania was barely under way before the Confederate batteries halted it. The

withdrawal of the 18th permitted the rebels to concentrate on the two-pronged charge of the 1st Vermont. The leading battalion, again commanded by Parsons, passed the Snyder house with little loss. Here it came abreast of a concealed Alabama regiment that took a heavy toll and forced the troopers to ride south over a stone wall to escape. Farnsworth, at the head of another Vermont battalion, was closer to Round Top. His force also jumped a stone wall and brushed aside a skirmish line. It turned east as if to strike the enemy rear only to confront a heavy flank fire. Above the Snyder house, the command encountered more infantry and artillery fire that inflicted losses. Farnsworth's horse dropped, but the general managed to extricate himself. He secured a riderless horse but, apparently disoriented, tried to return the way he had come. This time the foe was fully prepared. Someone called upon Farnsworth to surrender. When he refused, men from the 15th Alabama fired, striking him five times and killing him.

The cavalry action on the southern flank of the Federal army. Displaying tactical ineptitude, Kilpatrick had his men fight dismounted on ground suitable for mounted operations. He then made a mounted charge across rough, boulder-strewn, wooded slopes, only to be repulsed by Luffman's Georgians.

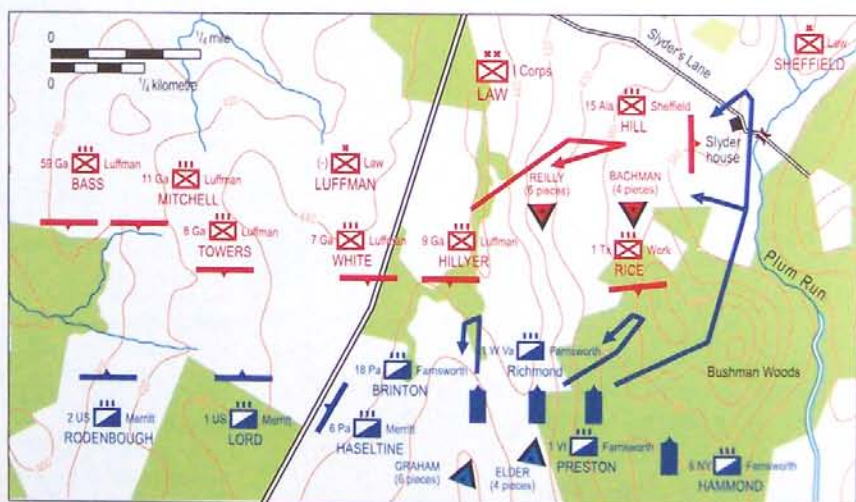

0400 hrs	0500	0600	0800	1000	1200	1300	1400	1500	1600	1700	1800
pages 75-76						35-4 & 91-95			17-19		
									90		

THE ARMY OF THE POTOMAC CAVALRY CORPS' BATTLES

Custer's and McIntosh's Brigades

Action at Rummel's Farm – 1300–1600 hrs

Brigadier-General David Gregg's assignment for July 3 was to guard Meade's right on the east side of Rock Creek. Accordingly, he deployed a long skirmish line from across Wolf Hill to the

Hanover Road. His cousin, Irvin Gregg, occupied the Wolf Hill portion of the line, while Colonel John McIntosh's Brigade manned the Hanover Road sector. McIntosh's Brigade was without two regiments that

The Union cavalry, assigned to defend the army's right-rear, had little idea that they were to face a stern challenge from Stuart's vaunted Confederate cavalry. The terrain was well suited to cavalry manoeuvre. The Union cavalry's performance on July 3 underscored the lesson of Brandy Station: Yankee troopers believed themselves equal to their rebel foes. Troopers in Custer's and McIntosh's Brigades also benefitted from capable, and sometimes inspired, leadership.

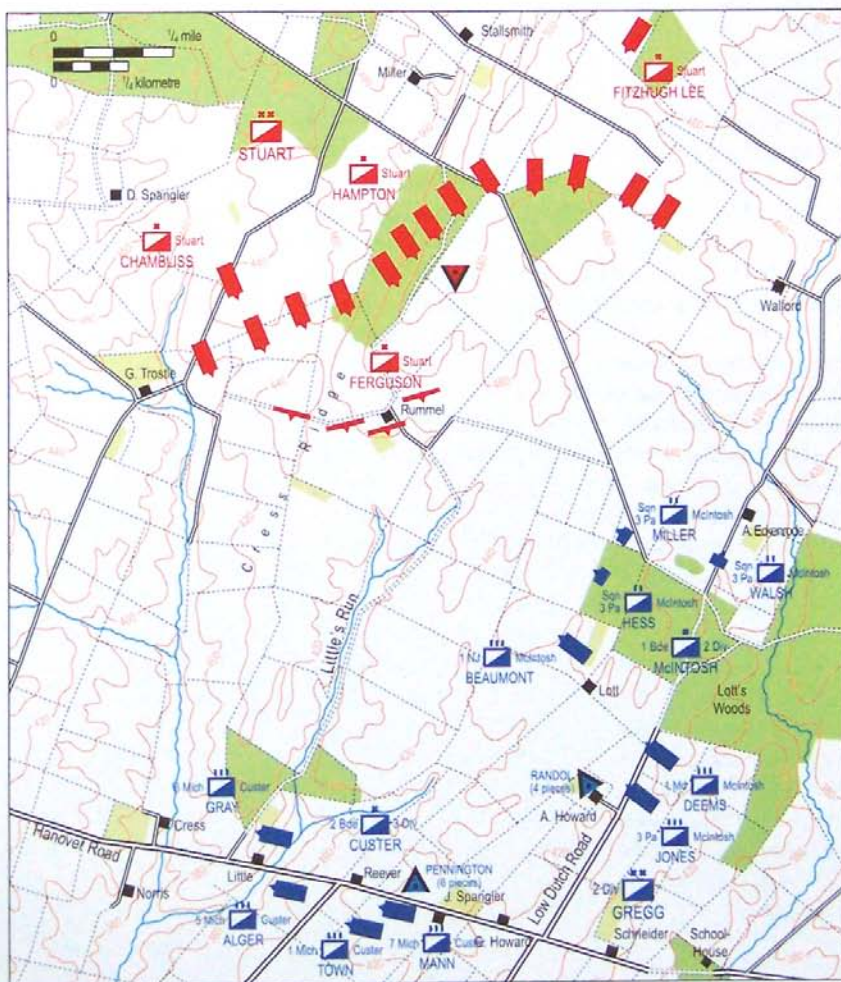

0400 hrs	0500	0600	0800	1000	1200	1300	1400	1500	1600	1700	1800
pages 75-76			35-4 & 91-95				17-19		90		

had been detached to protect the army's left flank. Gregg had temporary control of Brigadier-General George Custer's all-Michigan brigade. He stationed Custer west of the intersection of the Low Dutch Road and Hanover Road. At noon Kilpatrick requested Custer's return. Having decided that he was defending a key sector, Gregg jeopardised his career by ordering Custer to remain. It proved to be the right decision.

Unaware that a threat was emerging from Cress' Ridge, Custer initially deployed his forces around the road junction facing west. Only when Confederate artillery opened fire from the ridge did Custer realise where the enemy were. When McIntosh rode to Custer's headquarters to learn about the tactical situation and to report that his brigade was advancing to relieve Custer, the latter gestured towards the tree line atop Cress' Ridge and replied, 'I think you will find the woods out there ... full of them.'

McIntosh ordered Major Myron Beaumont to advance his 1st New Jersey Cavalry and present a skirmish line along a small stream near Rummel's Farm. Beaumont had reported sick just before a battle in the past. Purportedly, he did so again here and consequently the regiment's deployment was tardy. Angered, McIntosh shouted to an aide, 'Damn them, bring them up at a gallop.' So it fell to the often-wounded, 19-year-old Major Hugh Janeway to lead the

New Jersey troopers onto the field. McIntosh established his field headquarters at the Lott farmhouse. The 3rd Pennsylvania and 1st Maryland stood in column of squadrons in a clover field east of the Lott house.

The action began at about 1300 hrs when Ferguson's dismounted skirmishers, supported by artillery on Cress' Ridge, advanced southeast from Rummel's Farm. Dismounted bluecoats belonging to the 5th and 6th Michigan opposed them. However, because they expected soon to be relieved, they gave ground rather than become embroiled in a fight. Meanwhile, from the rear, exceedingly effective counter-battery fire delivered by two sections of Pennington's Battery drove a rebel battery from the ridge.

As the artillery fire subsided at about 1400 hrs, McIntosh sent two squadrons of the 1st New Jersey to relieve the Michigan skirmishers. They splashed across Little's Run and manned a position behind a line of fences.

An intense skirmish fight south of the Rummel's Farm began. The first blast from the 34th Battalion Virginia Cavalry caught some New Jersey troopers moving across an open field. The Yankees broke under the fire. Major Noah Ferry of the 5th Michigan tried to rally them, shouting 'Rally, boys! Rally for the

Combat initially focused on control of Rummel's Farm. Dismounted Federal troopers contested the stream bed and fence line along Cress' Run in a swirling action that eventually compelled the Confederate horsemen to launch a determined charge. In the past, such a Confederate charge might have swept the field. Here, the Federal commanders maintained their composure amid a confusing tactical situation.

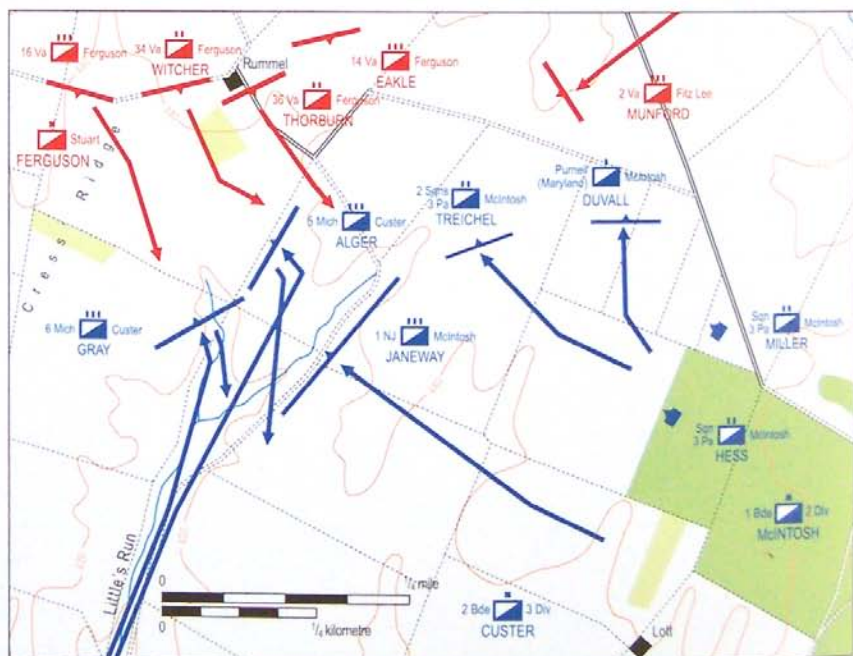

0400 hrs	0500	0600	0800	1000	1200	1300	1400	1500	1600	1700	1800
pages 75-76						35-4 & 91-95		17-19		90	

fence.' He fell with a mortal wound in the process.

To support his collapsing line, McIntosh committed two squadrons of the 3rd Pennsylvania and the Purnell Troop. A mounted squadron secured the right flank. The rest of his command remained in reserve near Lott's Woods. The opposing rebels fell back when they ran out of ammunition. However, from Cress' Ridge came new Confederate formations as Stuart fed in more men. The Confederates pressed hard along Little's Run and even drove back part of the 6th Michigan, which was north of McIntosh's line.

At this point, with the federal line wavering, Brigadier-General David Gregg appeared at the Lott house to assume command. Receiving a request from McIntosh for reinforcements, he directed two sections of Randol's Battery to sweep the Confederate position. 'Never,' reported Gregg, 'was there more accurate and effective fire.' Previously, rebel marksmen had used the shelter of the Rummel barn to pick off opponents along Little's Run. Randol's fire drove them from the barn and also turned the tide during this phase of the combat. Union troopers counter-attacked and drove the rebels from Rummel's Farm and up the slope of Cress' Ridge. They also occupied the fence line that had been held by the rebels, as well as some of the farm's outbuildings. A lull ensued, broken only by sporadic artillery exchanges.

Gregg knew that Custer had orders to depart and rejoin Kilpatrick. He asked Custer to remain. Although he had already sent part of his 6th and 7th Michigan marching southwest, Custer was not the sort of officer to turn his back on a fight. He ordered his regiments to counter-march and reassumed control of his troopers in the skirmish line.

The Union advance to Rummel's Farm provoked a Confederate response. A new line of dismounted rebels descended the slope and engaged. Now it was the turn for McIntosh's men to begin to run low on ammunition. Custer moved the 5th Michigan and four squadrons of the 6th Michigan to buttress the line. The 6th Michigan secured the Union left. However, fierce rebel artillery fire forced the 5th Michigan to take cover behind a post-and-rail fence before it managed to relieve McIntosh's men on the right flank. Here they received a dismounted attack from the 9th Virginia. Simultaneously, Fitz Lee's men struck the right of the Union line along Little's Run. By committing all available reserves, the Union line held. Alluding to the 5th Michigan, Custer later 'attributed their success in a

great measure to the fact that this regiment is armed with the Spencer repeating rifle ... the most effective fire-arm that our cavalry can adopt.'

However, a disadvantage of the Spencer was that a trooper tended to fire off his ammunition very quickly. Therefore, when the 5th ran low on ammunition the emboldened rebels came on again. When McIntosh looked about for his final reserve, the 1st Maryland, he discovered that Gregg had already moved the unit to the far side of Lott's Woods to address an imaginary threat. Here the 1st Maryland was out of supporting distance. Overcome by illness and frustration, McIntosh 'gave way to tears and oaths'. Suddenly, at the head of the inexperienced 7th Michigan, Custer appeared! The 7th was an exceptionally young outfit. Its troopers' average age was 18; its colonel, William Mann, was only 24. It was also Custer's weakest regiment, having only 10 companies. None of this mattered to Custer. Shouting, 'Come on, you Wolverines!' he led them in the day's first significant mounted charge. The regiment, formed in close column of squadrons, galloped diagonally across the field, through a mass of disordered troopers belonging to the 1st New Jersey, 3rd Pennsylvania, 5th Michigan and the Purnell Troop. It hacked its way through the 9th Virginia only to receive a volley from the 13th Virginia that compelled the Wolverines to make a turn to the left.

Then the regiment encountered the vaunted 1st Virginia across a post-and-rail fence, where the two lines exchanged carbine and revolver fire. The Union officers encouraged their men with cries of 'Kill all you can and do your best each for himself.' It was not the time for tactics but rather for naked courage at point-blank range.

Meanwhile, Custer led another part of the 7th Michigan towards the rebel batteries near Rummel's Farm. When about 200 yards short of the enemy guns, Custer realised that he was over-extended. He ordered a bugler to sound retreat. Just as the detachment was wheeling, two fresh Confederate regiments attacked its rear. The 7th put up a game fight; among many, it managed to kill the executive officer of the Jeff Davis Legion. Soon its fighting retreat lost all order. Then, some remounted Virginia cavalry hit its flank, causing the 7th to break badly. The panicked troopers ignored McIntosh's plea, 'For God's sake, men, if you are ever going to stand, stand now, for you are on your free soil!' The majority

0400 hrs	0500	0600	0800	1000	1200	1300	1400	1500	1600	1700	1800
pages 75-76						35-4 & 91-95	17-19			90	

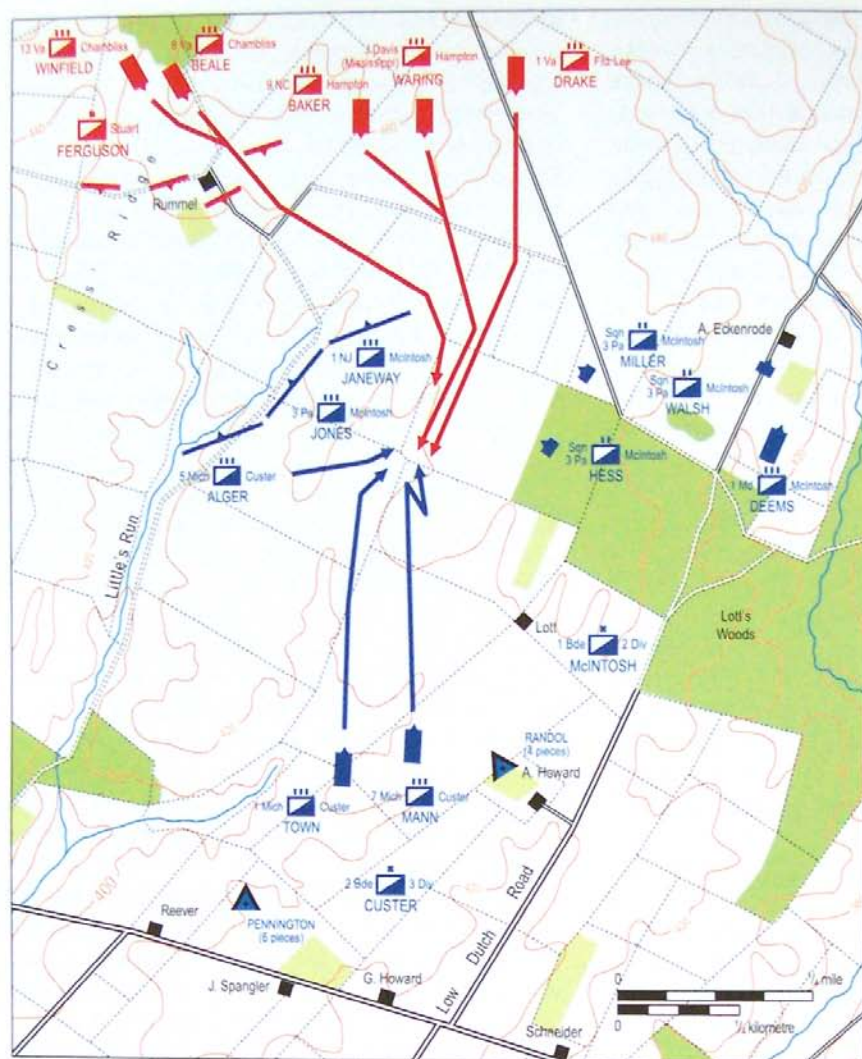

Custer met the Confederate charge with a characteristically reckless, unsupported counter-charge. Exhibiting a growing tactical confidence, junior Union officers displayed initiative and rescued Custer from his untenable position. The Yankee counter-attack stopped the rebel surge and with it any chance of Stuart making a breakthrough into the rear of the Federal infantry lines. The fighting ended on July 3 with both sides back in just about the same position as when the action had begun.

of men from four rebel regiments were pursuing the fleeing regiment. Only a self-sacrificing charge by two mounted squadrons of the 5th Michigan led by Major Luther Trowbridge slowed the pursuit. Trowbridge's troopers struck the flank of the 9th and 13th Virginia and sent these units flying. However, a surging Confederate wave featuring the 9th North Carolina and the Jeff Davis Legion overpowered Trowbridge's men. Trowbridge himself was unhorsed in the mêlée. However, his action purchased necessary time for the rest of the 5th Michigan to engage. They stopped the rebel pursuit. A sabre and pistol fight took place with the federals slowly gaining the advantage.

A mistake in the Confederate chain of command

now committed elements of three brigades to the fray. The Confederate troopers presented a dazzling spectacle: 'They marched with well-aligned fronts and steady reins,' a Yankee eyewitness recalled. Another federal officer related that 'the spectacle called forth a murmur of admiration'. McIntosh realised that the disorganised Union troops could not resist the forth coming charge. He sent his staff officers to recall the men and thus clear the field to give Randol's and Pennington's guns an unobstructed target. The Union horse artillery fired single and double canister against the oncoming line. The Confederates closed ranks as if nothing had happened. Dismounted marksmen on the Union right flank also punished the Confederates.

0400 hrs	0500	0600	0800	1000	1200	1300	1400	1500	1600	1700	1800
pages 75-76						35-4 & 91-95		17-19		90	

Gregg also realised that they would not be enough to stop the rebel horsemen. Either he, or Custer, or both, saw that the remaining reserve must charge. Custer rode to his most experienced unit, the 1st Michigan. He found it massed, in column of battalions, south of the Lott house. The regiment's colonel was a hard-bitten officer who had to lash his consumption-ridden body into the saddle in order to remain mounted. Some said that Colonel Town courted a death in battle in preference to wasting slowly away from disease. Custer spoke: 'Colonel Town, I shall have to ask you to charge, and I want to go in with you.'

Custer and Town led the 1st Michigan at a gallop toward Hampton's troopers. The rival lines collided 'like the falling of timber ... so sudden and violent ... that many of the horses were turned end over end and crushed their riders beneath them. The clashing of sabres, the firing of pistols, the demands for surrender and cries of the combatants now filled the air.'

Custer's own horse went down. He seized a riderless animal, remounted and returned to the action, wielding his long sabre in great sweeping arcs. A Union eyewitness described the column assault by the 1st Michigan: 'The squadrons, with almost faultless alignment, were hurled upon the largely superior numbers of the enemy, and as each squadron came up it was broken and forced out on either flank of the succeeding one, which filled its place, until over one-half of the regiment was broken up. But the rebels could not stand such terrible and rapid blows.'

Meanwhile, Gregg and McIntosh hurled every available man into the mêlée. Headquarters staff, buglers, and orderlies joined in. Captain Walter Newhall rallied 21 troopers and charged into the mass. Newhall hacked his way towards a Confederate flag and was almost within reaching distance of the prize when the standard-bearer lowered his staff and thrust it into Newhall's face. Pierced in the chin, his jaw shattered, the captain fell senseless to the ground. McIntosh and his staff pitched in. Rallied elements of the 5th and 7th Michigan returned. From the opposite flank, officers led a band of New Jersey troopers into the combat.

During this portion of the fighting, five out of seven Union officers in McIntosh's Brigade were wounded. One New Jersey trooper engaged Hampton himself and inflicted two head wounds. In the back-and-forth fighting, men became temporary prisoners only to turn on their captors when a new surge of friendly troops rescued them. The issue hung in the balance. Captain

William Miller and his squadron of the 3rd Pennsylvania were looking on from the edge of the Lott Woods. They were so close to the action that they could hear the distinct shouts of the Confederate officers. In prior combats the rebel horsemen had preferred the pistol to the sabre. Union troopers believed that their own willingness to engage with the sabre had given them an advantage. On this field they heard the rebel officers shouting, 'Keep to your sabres, men, keep to your sabres.' Miller turned to his subordinate, Lieutenant William Brooke Rawle, and said, 'I have been ordered to hold this position, but, if you will back me in case I am court-martialed for disobedience, I will order a charge.'

Thus, on his own initiative, Miller decided to attack the Confederate left flank. After firing a volley from their carbines, the Pennsylvania troopers drew their sabres and charged. Encouraged by their effort, adjacent formations pitched in as well. Miller's fresh troopers cleaved a path nearly all the way to the rear of the Confederate mass.

Nearing the Rummel's Farm lane, they became the target of the Confederate horse artillery. Its fire checked their advance. Miller was shot through his right arm and saw his sabre split in two by the fire. The detachment was now virtually isolated, deep in the enemy rear. He led his Pennsylvanians north until they escaped the fray and then back to their start position. Surprisingly they had suffered few losses. Miller would earn the Medal of Honor for his action. Indeed, by the time he led his men to safety, the Confederate tide was receding.

Union skirmishers again advanced towards Rummel's Farm. And so the 1st New Jersey, part of the 3rd Pennsylvania and the Purnell Legion occupied the same ground that they had held before the combat started. A sporadic artillery duel continued until nightfall. Stuart left a picket line in place and withdrew, leaving the Union forces in possession of the field. His attempt to attack the rear of the Union line had failed.

**Cavalry Corps Casualties at Gettysburg
July 3 1863**

Cavalry killed or wounded 257
Cavalry missing/captured 123
Artillery killed or wounded 23
Artillery missing/captured 0

0400 hrs	0500	0600	0800	1000	1200	1300	1400	1500	1600	1700	1800
pages 75-76						35-4 & 91-95	17-19				90

WARGAMING GETTYSBURG – July 3

The American Civil War has undergone a resurgence in interest among wargamers over the past 15 years. This may be attributed to a number of factors: firstly, a better understanding of the tactics and doctrines employed during the conflict; secondly, a heightened profile given to the conflict through television, film and literature (both fiction and non-fiction); and thirdly, the increased availability of high-quality wargames figures and models.

Figures and models

Below is a list, by no means comprehensive, of the main figure manufacturers. Many can be obtained from good model shops, or the addresses of the individual manufacturers can be found in most wargamers' magazines.

6 mm scale:

Heroics and Ross

15 mm scale:

Frei Korps 15
Essex Miniatures
AB Miniatures
Old Glory
MiniFigs (or Miniature Figurines)

25 mm scale:

Dixon Miniatures
Firing Line Miniatures
First Corps
Old Glory
Redoubt Enterprises
Wargames Foundry (also 54 mm scale figures for the skirmish maniac!)

Computer Games

Sid Meier's 'Gettysburg'
TalonSoft's 'Battleground2: Gettysburg'
Interactive Magic's 'American Civil War'

SELECT BIBLIOGRAPHY

Busey, John W. and Martin, David G. *Regimental Strengths and Losses at Gettysburg*. Hightstown: Longstreet House, 1994.

Coddington, Edwin B. *The Gettysburg Campaign: A study in Command*. New York: Charles Scribner's Sons, 1968.

Fox, William F. *Regimental Losses in the American Civil War, 1861-1865*. Albany: Albany Publishing Co., 1898.

Gallagher, Gary W., ed. *The Third Day at Gettysburg and Beyond*. Chapel Hill: University of North Carolina Press, 1994.

Luvas, Jay, and Harold W. Nelson, eds. *The U.S. Army War College Guide to the Battle of Gettysburg*. Carlisle, PA: South Mountain Press, 1986.

McClure, Alexander K., ed. *Annals of the War*. Edison, NJ: The Blue & Grey Press, 1996.

Naisawald, L. Van Loan. *Grape and Canister: The Story of the Field Artillery of the Army of the Potomac, 1861-1865*. New York: Oxford University Press, 1960.

Pfanz, Harry W. *Gettysburg: Culp's Hill and Cemetery Hill*.

Chapel Hill: University of North Carolina Press, 1993.

Priest, John Michael. *Into the Fight: Pickett's Charge at Gettysburg*. Shippensburg, PA: White Mane Books, 1998.

Raus, Edmund J., Jr. *A Generation on the March: The Union Army at Gettysburg*. Gettysburg: Thomas Publications, 1996.

Reardon, Carol. "I Think the Union Army Had Something to do with it": The Pickett's Charge Nobody Knows, in Gabor S. Boritt, ed., *The Gettysburg Nobody Knows*. New York: Oxford University Press, 1997.

Tagg, Larry. *The Generals of Gettysburg*. Campbell, CA: Savas Publishing, 1998.

U.S. War Department. *War of the Rebellion: A Compilation of the Official Records of the Union and Confederate Armies. Series I, vol. 27*. Washington: Government Printing Office, 1889.

Vanderslice, John M. *Gettysburg Then and Now*. Dayton, Ohio: Morningside Bookshop, 1983.

COMPANION SERIES FROM OSPREY

ELITE

Detailed information on the uniforms and insignia of the world's most famous military forces. Each 64-page book contains some 50 photographs and diagrams, and 12 pages of full-colour artwork.

NEW VANGUARD

Comprehensive histories of the design, development and operational use of the world's armoured vehicles and artillery. Each 48-page book contains eight pages of full-colour artwork including a detailed cutaway.

WARRIOR

Definitive analysis of the armour, weapons, tactics and motivation of the fighting men of history. Each 64-page book contains cutaways and exploded artwork of the warrior's weapons and armour.

CAMPAIGN

Concise, authoritative accounts of history's decisive military encounters. Each 96-page book contains over 90 illustrations including maps, orders of battle, colour plates, and three-dimensional battle maps.

MEN-AT-ARMS

An unrivalled source of information on the organisation, uniforms and equipment of the world's fighting men, past and present. The series covers hundreds of subjects spanning 5,000 years of history. Each 48-page book includes concise texts packed with specific information, some 40 photos, maps and diagrams, and eight colour plates of uniformed figures.

AIRCRAFT OF THE ACES

Focuses exclusively on the elite pilots of major air campaigns, and includes unique interviews with surviving aces sourced specifically for each volume. Each 96-page volume contains up to 40 specially commissioned artworks, unit listings, new scale plans and the best archival photography available.

COMBAT AIRCRAFT

Technical information from the world's leading aviation writers on the aircraft types flown. Each 96-page volume contains up to 40 specially commissioned artworks, unit listings, new scale plans and the best archival photography available.





ORDER OF BATTLE

GETTYSBURG BATTLEMAP

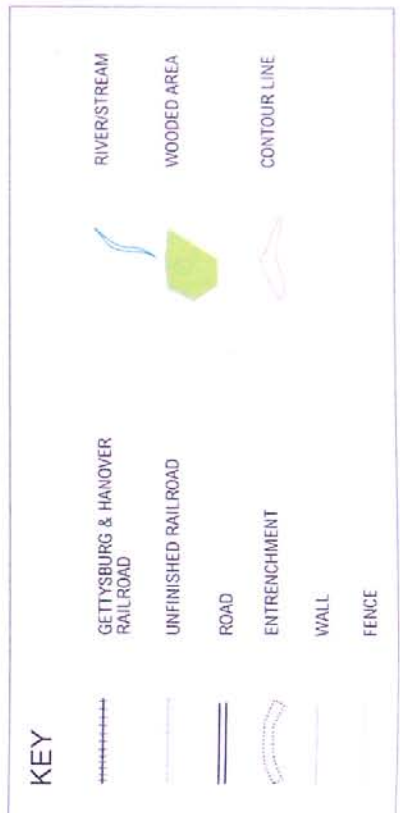

GETTYSB

UNION: THE ARMY OF THE P

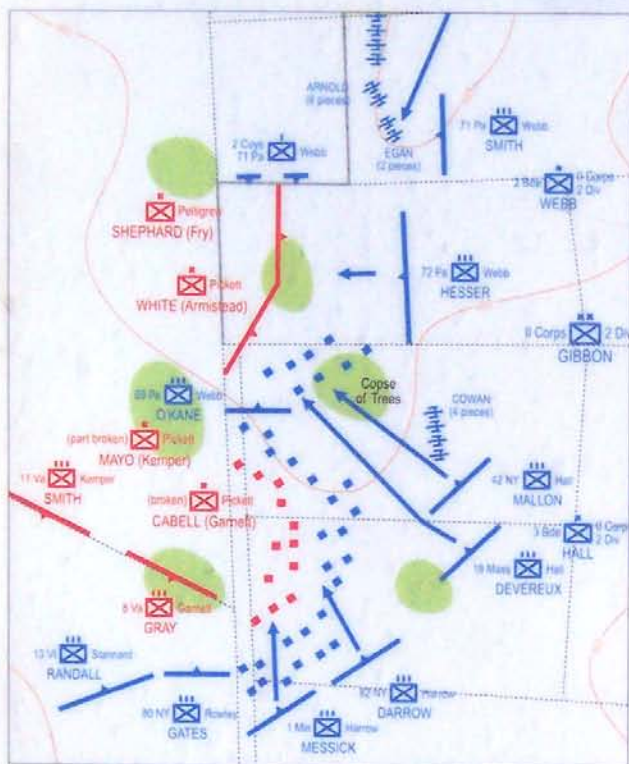

'The ...
and, a ...
war, v ...
remain ...
am not prepared to say, until better advised of
the condition of the army, whether my
operations will be of an offensive or defensive
character.'

General Meade's July 2nd dispatch to
General-in-Chief Halleck indicated the need to
assess the Federal predicament: to this end he called
a council of war. The thinking of his commanders
was best expressed by General Slocum of XII
Corps: 'Stay and fight it out.' As the meeting broke
up, Meade turned to General John Gibbon whose
division held the centre of the Federal line. 'If Lee
attacks tomorrow,' he said 'it will be on your front
... he has made attacks on both our flanks and
failed, and if he concludes to try again, it will be on
our center.' His judgment was to be proved correct
as the Confederates began to advance.

ORDER OF BATTLE SERIES

- Highly detailed illustrated references on the greatest battles in history, featuring unit-by-unit examinations of the troops and their movements, and analysis of the commanders' original objectives and actual achievements.
- Comprehensive organisational diagrams, detailed colour maps and a large fold-out base map combine to provide a unique visual approach.
- Authoritative and accessible.



Visit Osprey at www.ospreypublishing.com

OSPREY
MILITARY

ISBN 1-85532-861-5



9 781855 328617